

Lambda Transmitter LT3 Combination Probe KS1D



Table of Contents

1	Important Information about the Manual	4
1.1	Validity of these Instructions	4
1.2	Information on Using this Operating Manual	5
2	General Safety Instructions	6
2.1	Classification of the Safety Instructions and Warnings	6
2.2	Proper Use - Conditions of Use	7
2.3	Permissible Users	8
2.4	Safety Equipment/Safety Measures	9
3	Product Description	11
3.1	Designs and Accessories of the KS1D Combination Probe	11
3.2	C: Declaration of Conformity	13
4	Display and Operational Controls	15
4.1	Operation	16
4.2	Menu Structure	16
4.2.1	Password Entry Menu Structure	16
4.2.2	Information Menu Structure	17
4.2.3	Calibration Menu Structure	17
4.2.4	Settings Menu Structure	18
4.3	Status Line	19
4.4	Main Menu	20
4.4.1	Main Menu - Password Entry	21
4.4.2	Main Menu - Information	22
4.4.3	Main Menu - Calibration	23
4.4.4	Main Menu - Settings	24
4.5	LSB Remote Software (Optional)	25
4.6	External Operation via Programming Unit (optional)	26
5	Maintenance	27
5.1	Checking/Calibrating the KS1D Combination Probe	27
5.1.1	Checking/Calibrating the Air Voltage (Offset)	27
5.1.2	Checking/Calibrating the O ₂ Electrode	27
5.1.3	Checking/Calibrating the CO/H ₂ Electrode	27
5.1.4	Reading the Measured Values	28
5.1.5	Enter the Password for the Access Level	30
5.1.6	Activate/deactivate Maintenance Mode	31
5.1.7	Response of the Internal Resistance Regulation	32
5.1.8	Premature Cold Start Termination	33
5.1.9	Calibrating the Probe	34
5.1.9.1	Offset Calibration perform to 21 % O ₂	35
5.1.9.2	Calibrating the O ₂ Electrode in the Operating Point	37
5.1.9.3	Perform a Calibration of the CO/H ₂ Electrode	38
5.1.10	Checking/Calibrating with Test Gas	40
5.1.11	Checking/Calibrating with Reference Measurement	43
5.1.12	Simple Function Test of the CO/H ₂ Electrode	44
5.1.13	Wear-and-Tear Parts of the KS1D Combination Probe	44
5.2	Settings	45
5.2.1	Maintenance Mode	45

Table of Contents

5.2.2	Filter Time	45
5.2.3	Analogue Outputs	46
5.2.4	Replacing a Probe	46
5.2.5	Display	46
5.2.6	Limit Values	46
6	Correcting Faults	48
6.1	Faults and Warnings	48
6.1.1	Faults	48
6.1.2	Warnings	52
6.1.3	Call of the Fault History	54
7	Decommissioning	55
7.1	Decommissioning	55
7.1.1	Protection Against Emissions from Gas Carrying Channels	55
8	Options	56
8.1	Analogue Outputs via LSB Module Current, alternative Voltage, LSB address 19	56
8.1.1	Functional Description	56
8.1.2	Factory Setting of Analogue Outputs via LSB Module	57
8.1.3	Conversion of the Output Range via the User Interface	58
8.2	Digital Outputs via LSB Module, LSB Address 03 and 51	59
8.2.1	Functional Description	59
8.2.2	Factory Setting of the Digital Outputs	60
8.2.3	Settings	60
8.2.4	Diagnosis of the Digital Outputs	62
8.3	Digital Inputs via the LSB Module, LSB Address 11 and 55	63
8.3.1	Functional Description	63
8.3.2	Factory Settings of the Digital Inputs	64
8.3.3	Diagnosis of the Digital Inputs	64
8.4	Technical Data for HART Module	65
8.4.1	Functional Description	65
8.4.2	HART Commands and DIP Switch Settings	66
8.5	Field Bus Module for PROFIBUS PBM100	66
8.5.1	DIP Switch	66
8.5.2	LEDs	66
8.5.3	PROFIBUS DP Communication	67
8.5.4	Communication Appendix	68
8.5.5	External Connection	69
8.6	LSB Module for Calculating Combustion Efficiency	70
8.6.1	Functional Description	70
9	Storage	75
9.1	Storage Conditions	75
10	Disposal Notes	76
10.1	Environmental Protection, Waste Disposal	76
11	Appendix	77
11.1	Wet/Dry Measurement Deviations, Conversion Table	77

1 Important Information about the Manual

1 Important Information about the Manual

1.1 Validity of these Instructions

This manual describe the Lambda Transmitter LT3 with all required components. The information in this document applies to the software version V0.106. If you utilise a different version, this can lead to other effects to your device than those described in this manual.

NOTICE

LT3 Lambda Transmitter cannot be used for LAMTEC CO/O₂ Control.

1 Important Information about the Manual

1.2 Information on Using this Operating Manual

NOTICE

Before starting work, you absolutely must read these instructions!
Carefully observe all warning notes!

They contain important data and information, the compliance with which will ensure the function of the device and, in turn, reliable measurement results.

The device described here corresponds with the standard configuration.

Particular attention must be paid to **information** and **warnings**. These are indicated by respective pictograms. They serve to safeguard your personal safety and help you to avoid operating errors.

This operating manual contains the information required for the product to be used in a manner that is compliant with its intended use. It is intended for technically qualified personnel who are appropriately trained and who possess the relevant knowledge in the area of measurement, control and steering technology.

This operating manual is an inherent part of the delivery. For reasons of clarity, it is not possible to cover all possible designs of the described system. Please contact us if you wish to set up, operate, or maintain the device differently from the instructions given here.

2 General Safety Instructions

2 General Safety Instructions

2.1 Classification of the Safety Instructions and Warnings

The following symbols are used in this document to draw the user's attention to important safety information. They are located at points where the information is required. It is essential that the safety information is observed and followed, and that applies particularly to the warnings.

DANGER!

This draws the user's attention to imminent danger. If it is not avoided, it will result in death or very serious injury. The plant including its surroundings could be damaged.

WARNING!

This draws the user's attention to the possibility of imminent danger. If it is not avoided, it may result in death or very serious injury. The plant including its surroundings could be damaged.

CAUTION!

This draws the user's attention to the possibility of imminent danger. If it is not avoided, it may result in minor injuries. The plant including its surroundings could be damaged.

NOTICE

This draws the user's attention to important additional information about the system or system components and offers further tips.

The safety information described above is incorporated into the instructions.

Thus, the operator is requested to:

- 1 Comply with the accident prevention regulations whenever work is being carried out.
- 2 Do everything possible within his control to prevent personal injury and damage to property.

2 General Safety Instructions

2.2 Proper Use - Conditions of Use

Operation

The LT3 Lambda Transmitter is an electronic data interpreting device which is used in conjunction with the KS1D Combination Probe for the continuous measurement of the O₂ concentration and the oxidising components (CO/H₂) in non-combustible gases in the superstoichiometric area.

Prerequisites

It is assumed that plant planning, mounting, installation, commissioning, maintenance, and service work will be carried out by sufficiently trained personnel and that this work will be checked by responsible skilled personnel. It must be particularly noted that

- the operation complies with the technical data and specifications regarding permissible use, mounting, connection, and environment and operating conditions (refer to the contract documents, the device user information, rating plates, etc.).
- work will be carried out in accordance with the local, plant-specific circumstances and with regard to the operational risks and directives.
- all the measures required to preserve the value, e.g. for transportation and storage as well as maintenance and service, are maintained.

Intended use

The product described here has left the factory in a flawless, safe and checked condition and it must be maintained exclusively in the manner that is described by the manufacturer. Equally, the proper transportation, correct storage and setup as well as the careful operation and maintenance, are critical for the flawless and safe operation of the device. Sufficiently qualified personnel must be used to install and operate this product. They must be familiar with the security advice and warnings specified here and ensure they can be implemented flawlessly. Unqualified persons working on the device or the warning information provided here or on the device not being observed could result in serious personal injury and / or damage to property. The device is being used as intended if the device is being used solely for the application specified in the technical description. Auxiliary devices or those from other manufacturers must be recommended or authorised by LAMTEC. Provided the safety information and operating directives specified in this manual are observed, this device should not present any risks in terms of damage to property or the health of personnel.

2.3 Permissible Users

Qualified personnel

The person responsible for safety absolutely must guarantee that

- only qualified personnel perform work on the system parts.
Due to their training, education, experience, or instruction and due to their knowledge of pertinent standards, provisions, accident prevention regulations, and system conditions, qualified personnel are authorized to perform these tasks by the person responsible for the safety of people and the system. It is decisive that this personnel must be able to recognise and prevent risks on time.
Experts are considered to be people according to DIN VDE 0105 or IEC 364 or directly comparable standards like DIN 0832.
- These persons must have access to the provided operating manual and any pertinent order-related documentation during all work and observe these documents within the scope of preventing risks and damage.

User groups

For the handling of the Lambda Transmitter LT3, three user groups are required:

- Service technicians of LAMTEC or its OEM customers and/or trained customer personnel:
 - Qualified technicians/engineers → have very good knowledge of the device.
 - SERVICE access level - password-protected
- Operators, customer fitters, technicians for instrumentation and control technology, electricians, and electronic engineers → have introductory knowledge of the device.
 - CUSTOMER access level - password-protected
- Operating personnel with basic knowledge
 - OPERATION access level - no password

2 General Safety Instructions

2.4 Safety Equipment/Safety Measures

Hazards from electrical equipment

The LT3 and the Lambda Transmitter Combination Probe is equipment for use in industrial electrical power installations. Always switch off the power when working on mains connections or mains voltage. If contact protection has been removed, reattach it before switching on the power supply again. Damage to health or equipment may result from improper use or improper handling.

NOTICE

To avoid damage, always observe the respective security notices.

Preventive measures for improving operating safety

If the LT3 is used in conjunction with control and steering technology, the operator must ensure that any breakdown or failure of the LT3 device does not cause inadmissible damage or dangerous operating states. To avoid faults which could cause direct or indirect personal or material damage, the operator must ensure that:

- the responsible maintenance personnel can be reached at any time and as quickly as possible
- the maintenance personnel are trained to correctly respond to faults with the LT3 Lambda Transmitter and the associated malfunctions
- in the case of doubt, the faulty equipment can be switched off immediately
- A switch-off does not lead to direct follow-up problems.

Avoiding consequential damages

To avoid consequential damages in the event of failure, which could cause direct or indirect personal or material damage, the owner must ensure that qualified personnel can assess the faults and initiate appropriate measures to tackle them.

Protect against gas leakage from the gas-bearing channel

The Combination Probe KS1Dis fitted directly to the gas-bearing channel via the probe installation fitting (PIF). If the Combination Probe KS1D or the probe installation fitting (PIF) are dismantled, depending on the plant but particularly in the case of excess pressure, aggressive and / or hot gas can seep out of the channel and this could pose a serious health hazard to an unprotected operator if suitable safety measures have not been taken previously. For prevention, suitable protective measures must be taken in advance.



WARNING!

In the case of excess pressure and temperatures in excess of 200 °C in the gas channel, gases could escape when dismantling the Combination Probe KS1D or the probe installation fitting (PIF).

- ▶ Always switch off the plant prior to opening. If this is not possible, wear protective clothing and a mask.
- ▶ Fix respective warning information in close proximity to the mounting site.
- ▶ Immediately seal the opening again.

2 General Safety Instructions



WARNING!

Danger from electrical shock

The device contains live parts and touching these parts could cause electric shock.

- ▶ Before opening the housing, disconnect the mains plug!
-

Decommissioning/recommissioning

The Lambda Transmitter LT3 Combination Probe KS1D are a high-quality, electronic measuring system. It therefore requires careful handling in all situations - decommissioning, transport, and storage.

NOTICE

Do not switch off the Lambda Transmitter LT3 as long as the KS1D Combination Probe is mounted. Not even if the associated plant has been brought to a standstill. Residual gases will cause corrosion and could damage the probe.

- ▶ Do not store the device outside without any protection!
 - ▶ Always store in a dry location and, if possible, keep in the original packaging.
 - ▶ When uninstalling, protect the ends of cables and the connectors from corrosion and soiling. Corroded connectors can cause malfunctions.
 - ▶ If possible, always transport in the original packaging.
-

3 Product Description

3 Product Description

3.1 Designs and Accessories of the KS1D Combination Probe

The KS1D Combination Probe permits a simultaneous measurement of the O₂ concentration and combustible, oxidising gas components (CO/H₂) displayed as CO equivalent (CO_e), in the flue gases from combustion systems in the superstoichiometric area ($\lambda > 1$) in situ (directly in the flue gas).



Fig. 3-1 Standard design of the KS1D Combination Probe

- 1 KS1D Combination Probe in standard housing
Standard cable length 2 m, FEP, with connecting plug
- 2 Probe installation fitting (PIF)
- 3 Measuring gas extraction device (GED)



Fig. 3-2 KS1D Combination Probe without housing

Alternatively:



Fig. 3-3 KS1D Combination Probe in HT design

- 1 KS1D-HT Combination Probe high-temperature
Standard cable length 2 m, FEP, with connecting plug
- 2 Flue gas bypass tube

3 Product Description

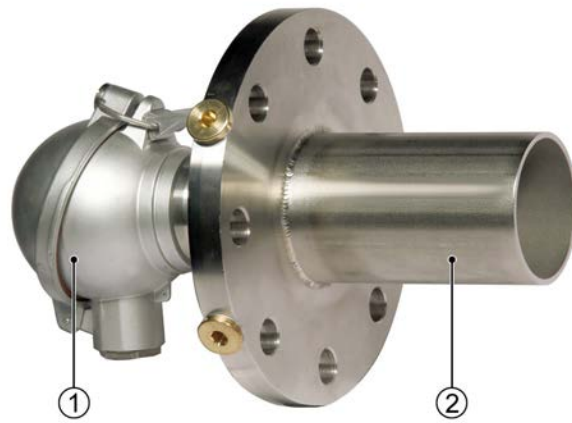

Fig. 3-4 KS1D Combination Probe for manual cleaning

- 1 KS1D-HT Combination Probe
- 2 High dust reception flange with pneumatic fittings

3.2 C: Declaration of Conformity



EU-Konformitätserklärung

EU Declaration of Conformity
Déclaration de Conformité UE

Wir
We / Nous

LAMTEC Meß- und Regeltechnik für Feuerungen GmbH & Co. KG
Wiesenstraße 6
D-69190 Walldorf (Baden)

erklären,
dass das Produkt
declare that product /
déclarons que produit

LT3 – Lambda Transmitter

inklusive
inclusive / y compris

Varianten
variants / variants

LT3 im Wandaufbauehäuse

657R51

LT3 in wall mounting housing / LT3 coffret mural

ohne Anzeige (IP66)

657R51-00...

Without display / sans affichage

mit erweiterter Bedieneinheit (IP65)

657R51-10...

With extended display and operation unit /

Avec Unité d'affichage et de opération étendue

mit User Interface UI300 (IP54)

657R51-20...

With User Interface UI300 / avec User Interface UI300

Sonden

probes / sondes

KS1D

656R2000

656R2010

KS1D-HT

656R2015

mit Optionen

with options / avec options

Sondenanschlusskasten SAK

656R3025

Probe connection box PCB /

Bóítier de raccordement de sondes BRS

Feldbusmodul PBM100 für PROFIBUS DP

657R5950

Field bus Module PBM100 for PROFIBUS DP /

Module bus de terrain PBM100 PROFIBUS DP

LAMTEC Meß- und Regeltechnik für Feuerungen
GmbH & Co. KG
Wiesenstraße 6
D-69190 Walldorf (Baden)

Telefon: +49 6227 6052-0
Telefax: +49 6227 6052-57

Internet: www.lamtec.de
E-Mail: info@lamtec.de



auf welche sich diese Erklärung bezieht, mit den folgenden Norm(en) übereinstimmt
to which this declaration relates conforms to the following standard(s)
sur laquelle cette déclaration se réfère, et conformément aux dispositions de la norme(s)

DIN EN 61326-1: 2013-07
DIN EN 61010-1: 2011-07

gemäß den Bestimmungen der folgenden Richtlinie(n).
according to the provisions of the following directive(s) / conformément aux dispositions de la directive(s)

Nummer (Number / Numéro)	Text (Text / Texte)
2014/35/EU 2014/35/EU/ 2014/35/UE	Niederspannungsrichtlinie Low Voltage Directive Directive basse tension
2014/30/EU 2014/30/EU 2014/30/UE	EMV-Richtlinie EMC Directive Directive CEM
2011/65/EU 2011/65/EU 2011/65/UE	RoHS RoHS RoHS

Das Datenblatt und gegebenenfalls die Basisdokumentation sind zu beachten.
The data sheet and basic documentation, if any, have to be considered.
La consultation de la fiche technique, et éventuellement de la documentation technique de base, est requise.

Hinweise zur Anwendung der Richtlinie 2014/30/EU:
Die Konformität mit 2014/30/EU gilt für die Verwendung in industrieller Umgebung.

Remarks regarding the application of directive 2014/30/EU:
Conformity with 2014/30/EU only in industrial environment.

Remarques sur l'application des directives 2014/30/UE:
La conformité avec la 2014/30/UE est valable dans un environnement industrielle

Anbringung der CE-Kennzeichnung: **ja**
Placing of the CE marking / L'apposition du marquage CE

Rechtsverbindliche Unterschrift
Authorized signature / Signature autorisée

Walldorf, 20.04.2016
H. Weber, General Manager

LAMTEC Meß- und Regeltechnik für Feuerungen
GmbH & Co. KG
Wiesenstraße 6
D-69190 Walldorf (Baden)

Telefon: +49 6227 6052-0
Telefax: +49 6227 6052-57

Internet: www.lamtec.de
E-Mail: info@lamtec.de

4 Display and Operational Controls

To display and operate LT3, the user interface is integrated into the front door of LT3 (included in the standard).

Functions:

- Reading of the O₂ and CO_e measured values
- Password entry
- Information → regarding the probe, fuel, warnings, faults, software version, CRC, and serial number
- Calibration of measurement
- Settings → maintenance, filter time, analogue output, probe replacement, display, limit values, and digital outputs



Fig. 4-1 LT3 user interface





Fig. 4-2 Housing with user interface

4 Display and Operational Controls

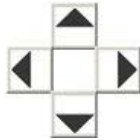

4.1 Operation



Using the arrow keys     you can navigate within the menus.

In the process, move the keys  and  to the right or left by one to make a selection.

ENTER  ENTER takes you to menu entries or to the edit mode in the case of selected parameters or values.

With the keys  and  the currently selected value can be changed accordingly. Hold down the respective key and the value will count automatically up or down.

BACK  BACK leaves the window, menu, or edit mode.

4.2 Menu Structure

4.2.1 Password Entry Menu Structure

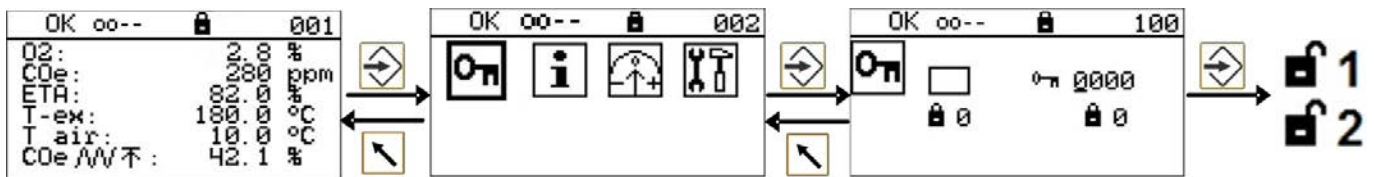

 Without access level

 Customer access level

 Service access level

4 Display and Operational Controls

4.2.2 Information Menu Structure

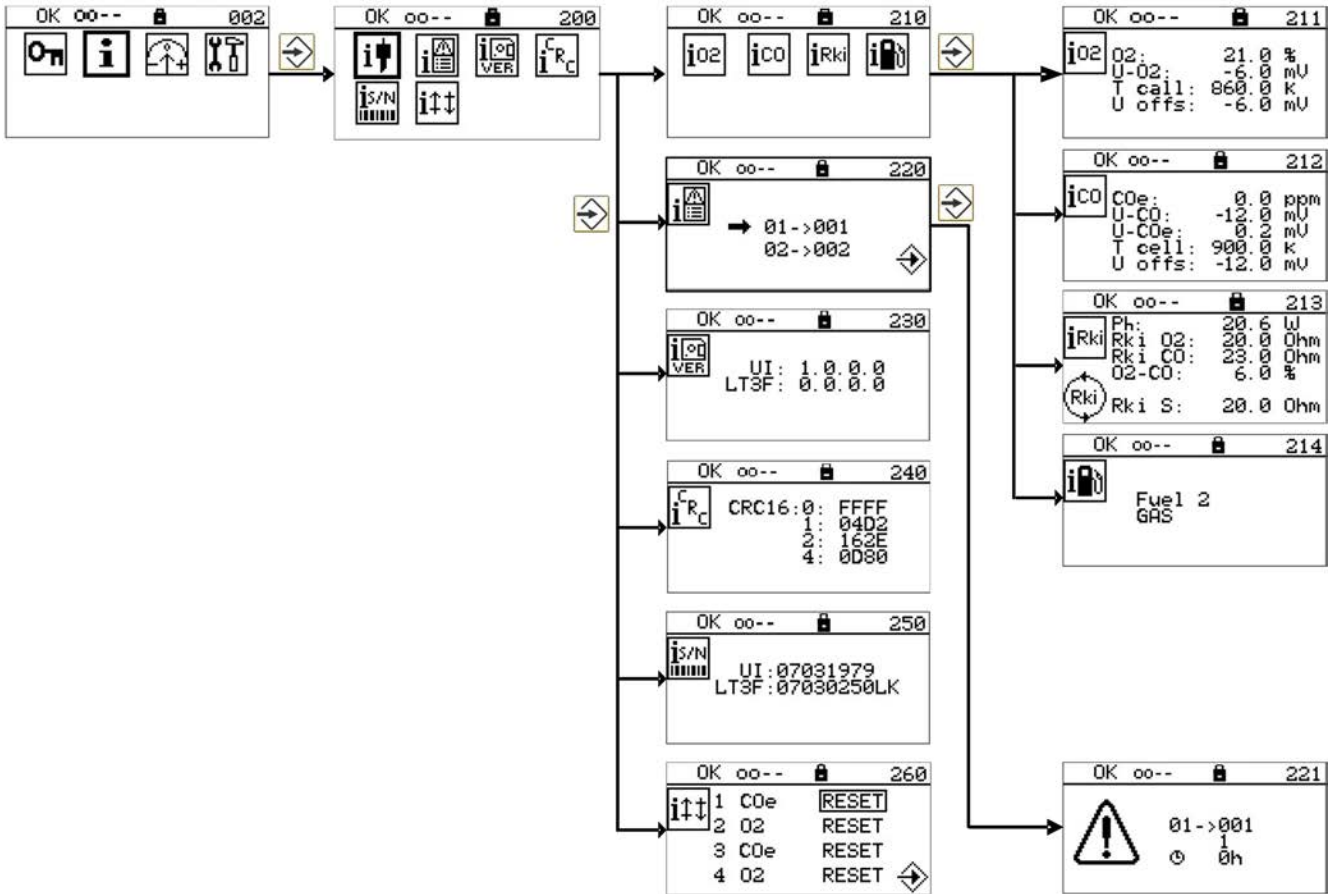

4.2.3 Calibration Menu Structure

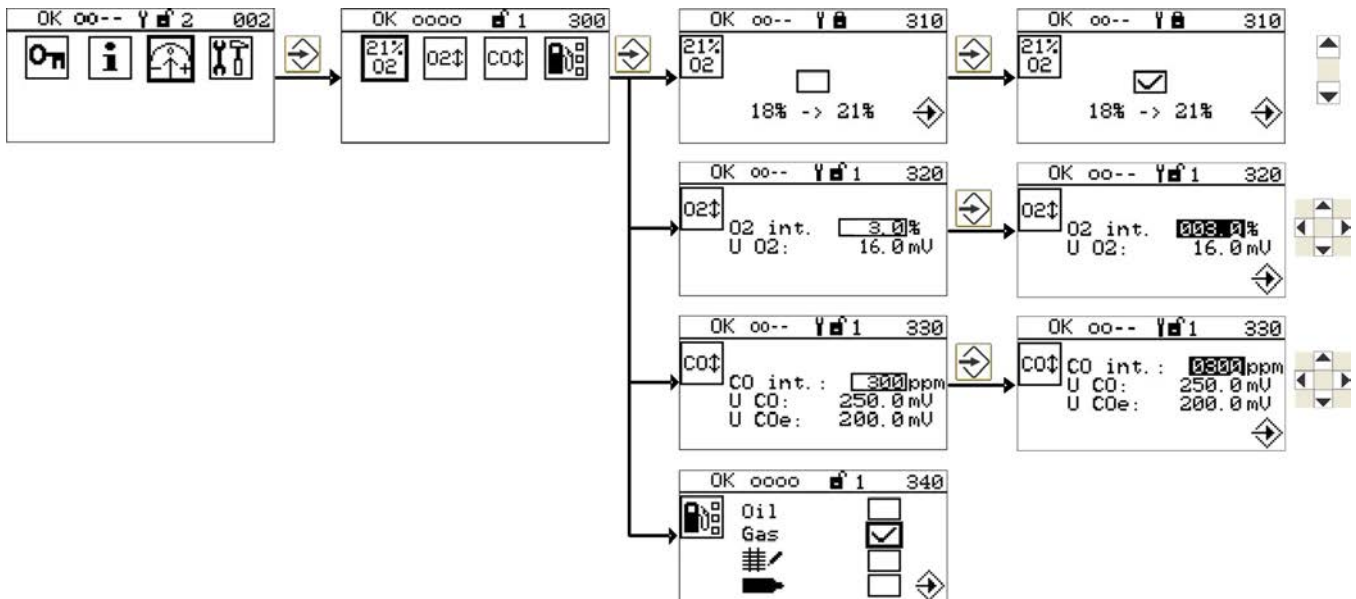

4 Display and Operational Controls

4.2.4 Settings Menu Structure

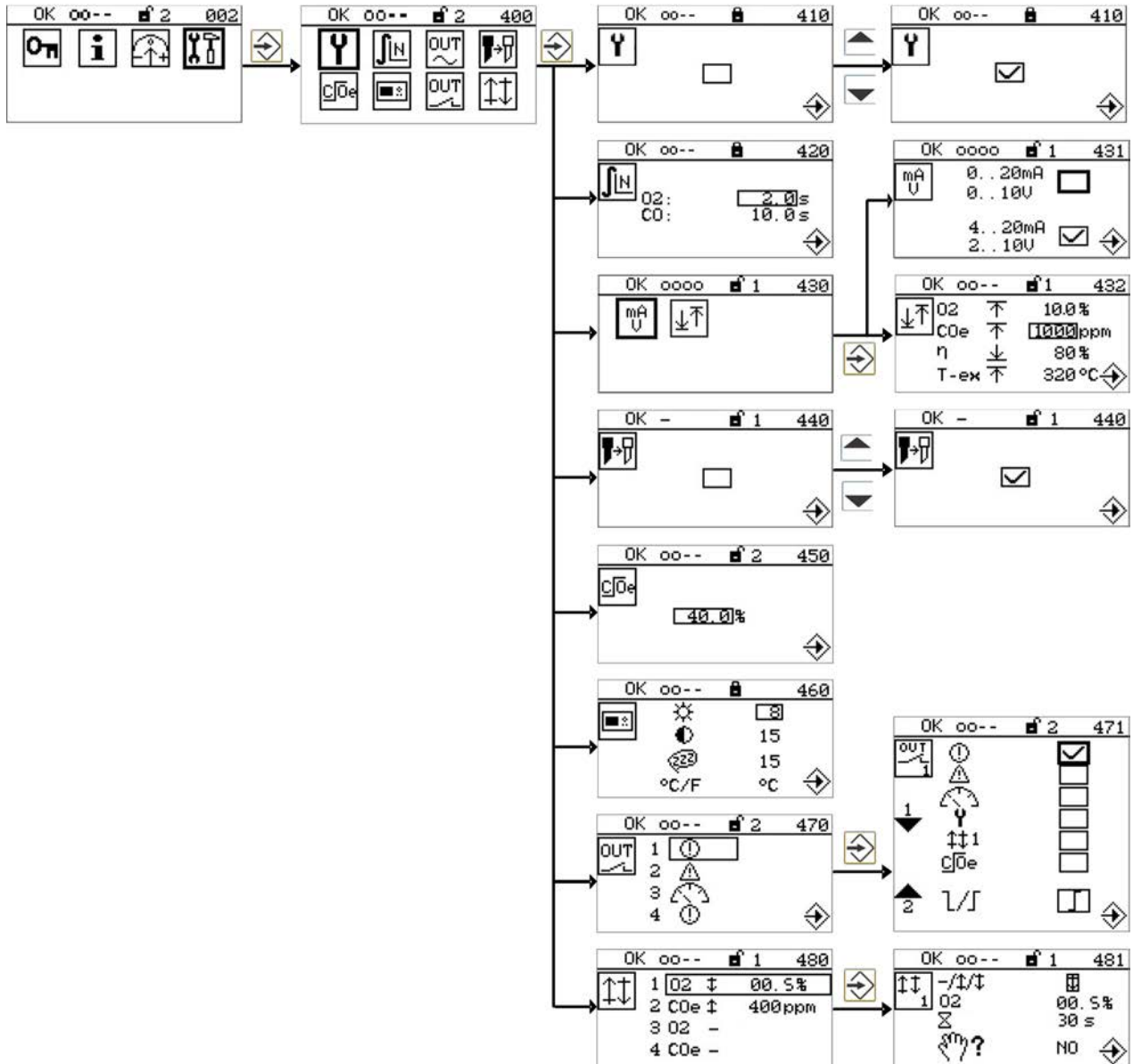

4 Display and Operational Controls

4.3 Status Line

The status line contains information about LT3, including the device family.







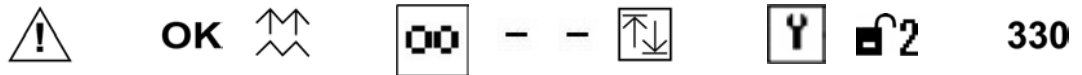







Fig. 4-3 UI300 front view status line

1. Status line



Description status line:

-  Active fault/warning
- OK** Operating mode OK
-  Heat-up (cold start)
-    Status of limit values 1-4*
-  Active limit value not triggered
-  Non-active limit value (off)
-  Active limit value undershot/exceeded
-  Active maintenance mode
-  Without access level
-  Access level 1 - Customer
-  Access level 2 - Service
- 330** Window number

* If a limit value is exceeded the display shows an upward or downward arrow.

4 Display and Operational Controls

4.4 Main Menu

Main display

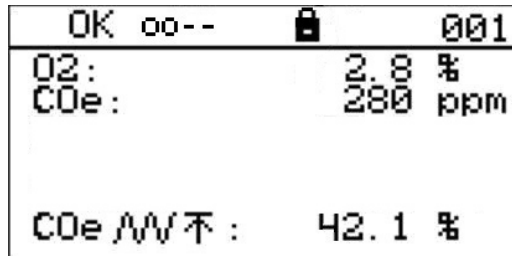

Main menu

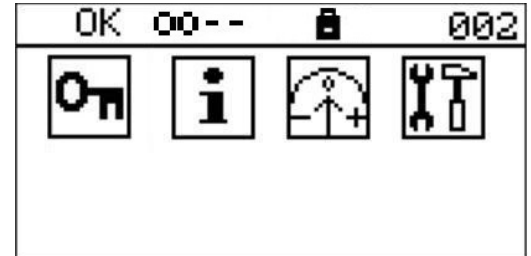

The following values are displayed:

- O₂ value, resolution 0.1%
- CO_e value (recommended 1,000 ppm), resolution 1 ppm
- CO_e:  Probe signal dynamics
- \uparrow CO edge signal reached/exceeded

NOTICE

In case of overflow/underflow of the measuring range, the corresponding measured values flash

Press ENTER  to access the main menu.

Meaning of the symbols:



Password entry



Information regarding the probe and fuel, warnings and faults, software version, CRC, and serial number



Calibration of measurement



Settings (maintenance, filter time, analogue output, probe replacement, display, limit values and digital outputs)

4 Display and Operational Controls

4.4.1 Main Menu - Password Entry

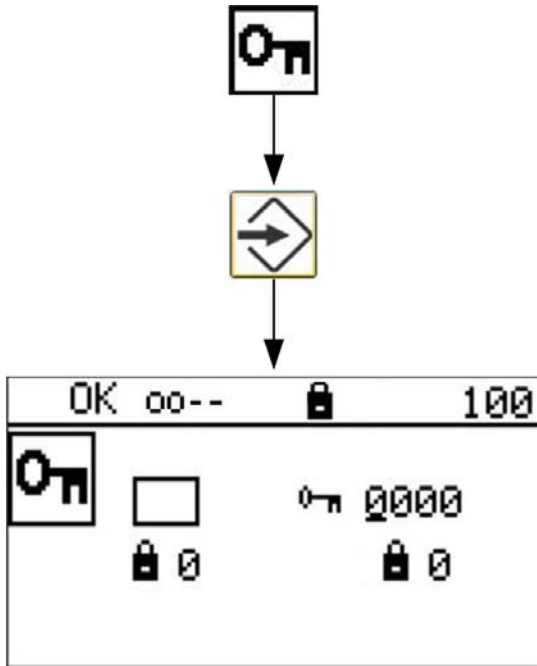





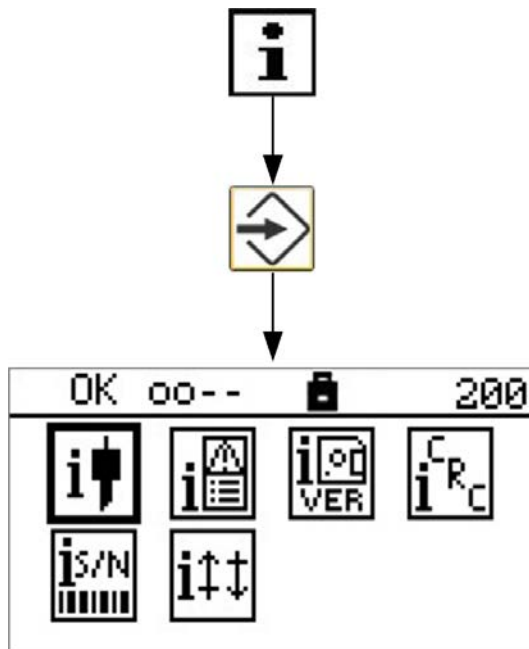

4 Display and Operational Controls

4.4.2 Main Menu - Information



Meaning of the symbols:

-  Measured values and probe data
-  Fault/warning history
-  Software version of LT3 and display
-  CRC checksums
-  Serial number
-  Manual reset of the limit values if they are set to manual reset

4 Display and Operational Controls

4.4.3 Main Menu - Calibration

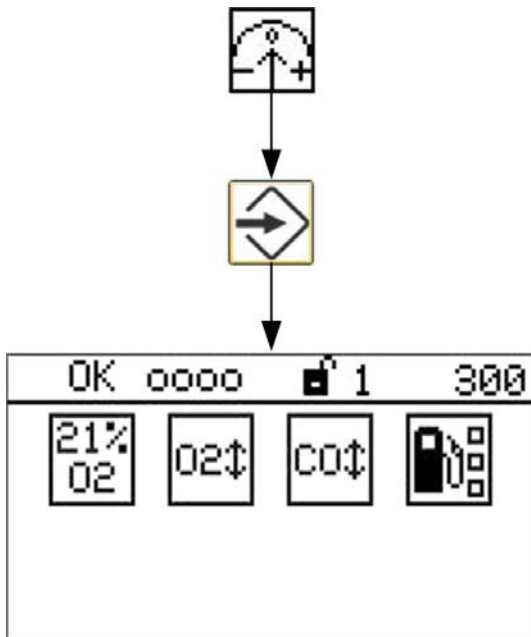

Meaning of the symbols:



Offset of calibration to 21% O₂ (air calibration)



CO_e calibration



O₂ calibration



Fuel changeover

Required access level

Without

At least 1 (Customer) or higher

At least 1 (Customer) or higher

At least 1 (Customer) or higher

4 Display and Operational Controls

4.4.4 Main Menu - Settings

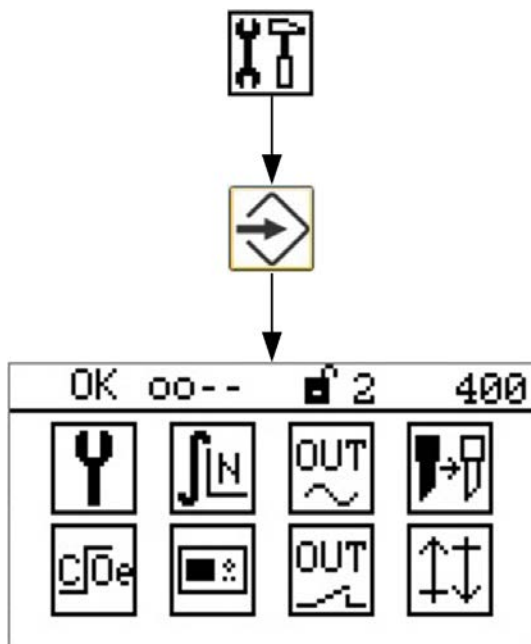

Meaning of the symbols:



Maintenance mode



Filter time of the measured values



Analogue outputs



Triggering of probe replacement



CO trigger threshold



Display parameters



Digital outputs



Limit values

Required access level

Without

Without

At least 1 (Customer) or higher

At least 1 (Customer) or higher

At least 2 (Service)

Without

At least 2 (Service)

At least 1 (Customer) or higher

4 Display and Operational Controls

4.5 LSB Remote Software (Optional)

The LSB remote software offers:

- Remote software for PC as of Windows XP
- Full access to the parameter level, password-protected
- Reading, writing, and comparison of data records
- Including connecting cable for USB/CAN module – LT3, length of 4 m.
For connection to the existing 5-pole M12 socket
- Including USB/CAN module type 657R9000
- Without USB/CAN module type 657R9001

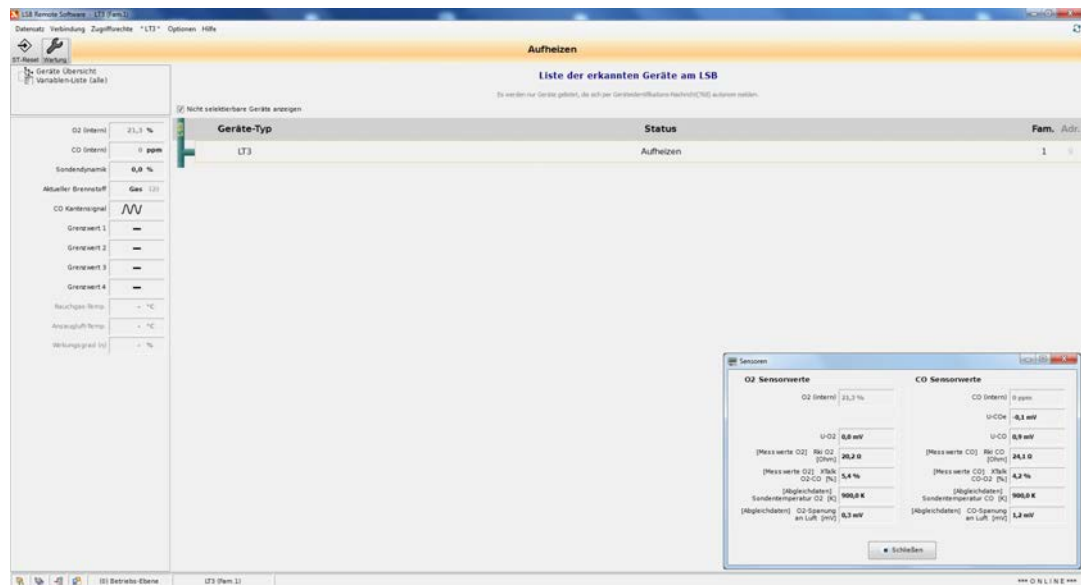

A description of the LSB remote software can be found in a separate document.

If the LSB remote software is active, the operation to the user interface is inactive!

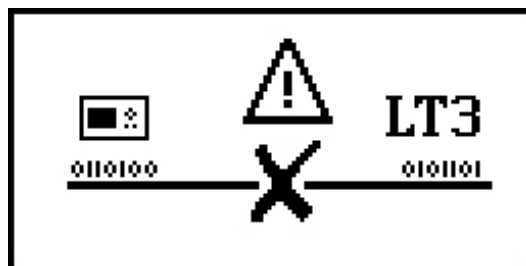

4 Display and Operational Controls

4.6 External Operation via Programming Unit (optional)



- Operation and Parameter Settings
- Full access by password to the parameter level
- Read and write datasets
- Including connecting cable, length 4 m, to connect to the existing 5 pole M12 socket.
- Order no. 657R0932

5 Maintenance

As a result of extensive self-diagnosis, the measuring system is essentially maintenance-free. Maintenance is restricted to the calibration and the cleaning of dust or other deposits; as well as the cyclic replacement of the ZrO₂ measuring element.

5.1 Checking/Calibrating the KS1D Combination Probe

The checking / calibration should (advantageously installed) be built in at normal operating temperature and carried out under operating conditions.

Recommended time spans (cycles):

- 6 hours after commissioning
- 12 months for natural gas combustion systems

5.1.1 Checking/Calibrating the Air Voltage (Offset)

1. Switch off the plant.
If you cannot switch off the plant, the probe must be dismantled. Observe the safety notices!
2. Pre-ventilate, until there is no longer any flue gas at the measuring point (about 1 minute).
3. End the pre-purge.
4. Perform the offset calibration of the O₂ (U-O₂) and CO/H₂ (U-CO) electrodes.
See Chapter 5.1.9.1 *Offset Calibration perform to 21 % O₂*.

5.1.2 Checking/Calibrating the O₂ Electrode

See Chapter 5.1.11 *Checking/Calibrating with Reference Measurement*.

5.1.3 Checking/Calibrating the CO/H₂ Electrode

See Chapter 5.1.9.3 *Perform a Calibration of the CO/H₂ Electrode*.

5 Maintenance

5.1.4 Reading the Measured Values

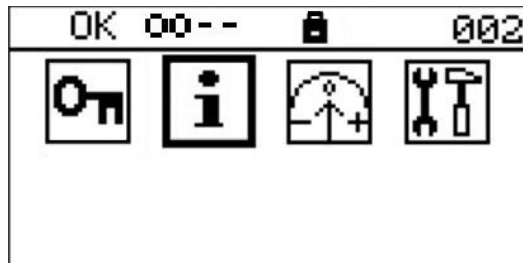

In the main menu, select the INFORMATION menu with **i**.

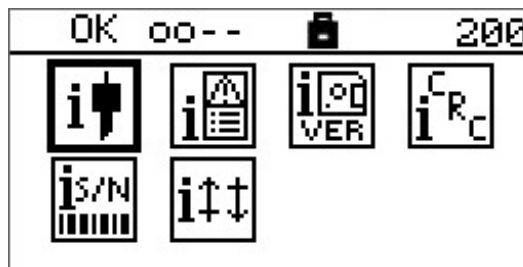

In the INFORMATION menu, select measured values and probe data with **i**.



In MEASURED VALUES and PROBE DATA, select:

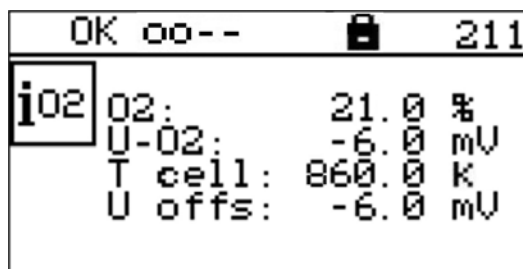

- iO₂** Display of the O₂ measured values
- iCO** Display of the CO_e measured values
- iR_{ki}** Display of the R_{ki} internal probe resistances
- iFuel** Display of the current fuel selection

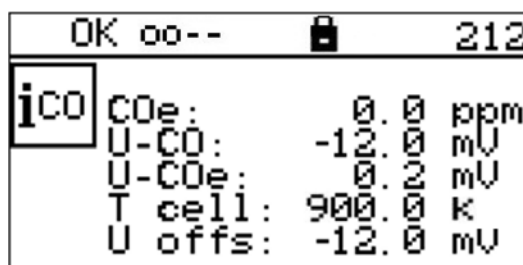

The O₂ probe voltage U-O₂ stabilises to values between +10 ... -20 mV.



The CO probe voltage U-CO stabilises to values between +10 ... -20 mV.

OK oo--		213	
	Ph:	20.6	W
	Rki O2:	20.0	Ohm
	Rki CO:	23.0	Ohm
	O2-CO:	6.0	%
	Rki S:	20.0	Ohm

The R_{ki} internal probe resistance values lie between 15 ... 25 Ω .

 Display of whether the internal probe resistance regulation is active!

P_h Display of the current heating capacity

$R_{ki} S$ Display of the setpoint value for the internal resistance regulation.

O_2-CO : Evaluates the cross-talk response between the O_2 and CO electrodes. If the influence is too large (>15 %), the sensor signals overwrite each other.

OK oo--		214	
	Fuel 2		
	GAS		

Currently selected fuel.

5 Maintenance

5.1.5 Enter the Password for the Access Level

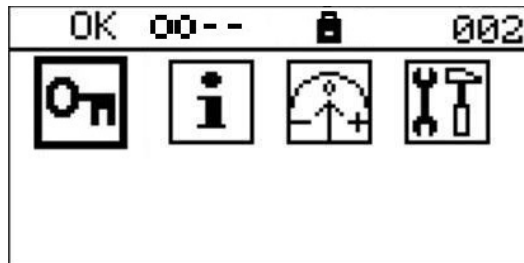

In the main "Password Entry" menu, select .

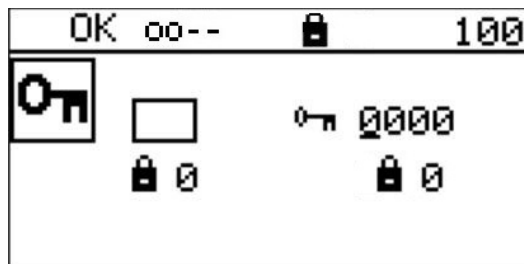

Enter password via     and ENTER .

Access level 1: Customer Level
Factory setting: 0000 – access to customer functions only

Customers can change the password for access level 1. For details ask the burner manufacturer/supplier

Access level 2: Service level
Password: customer specific
Access to customer and service functions

5.1.6 Activate/deactivate Maintenance Mode

In maintenance mode, the majority of test routines are disabled. It is advantageous to activate the maintenance mode during probe calibration. Fixed substitute values can be set as an output during active maintenance mode.

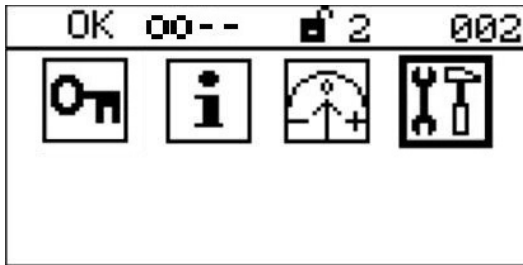

In the main SETTINGS menu, select

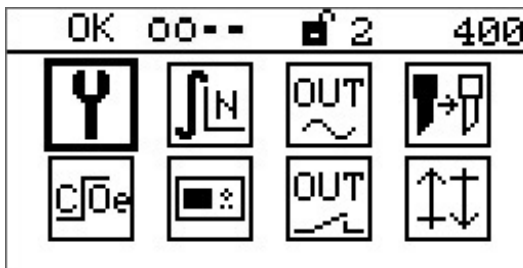

In the MAINTENANCE MODE settings, select

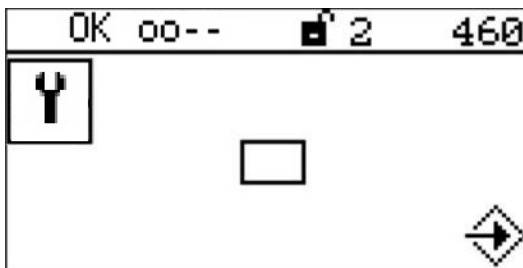

Menu 460 ACTIVATE/DEACTIVATE MAINTENANCE MODE is opened.



Select with the key and ENTER to activate/deactivate the maintenance mode.

Activate maintenance mode

Deactivate maintenance mode

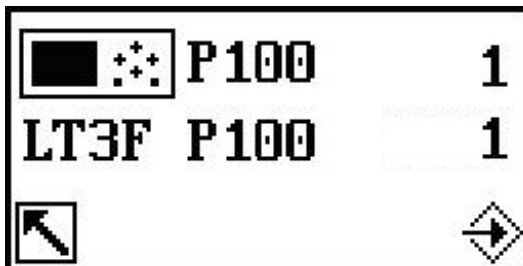

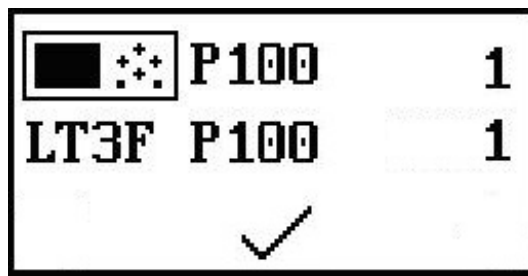

If both parameters (LT3 and UI300) are equal confirm the procedure with ENTER

Note the time limit: 8 s

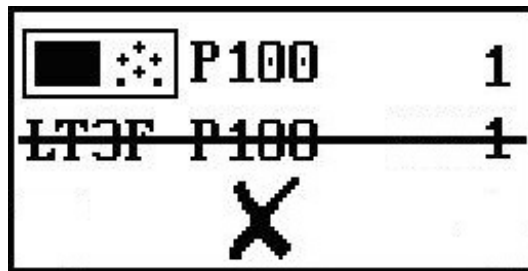

Wait for transmission end indication. Return to the SETTINGS menu with the BACK  and repeat the procedure.



In case of cancelling or timeout, this display appears. Return to the SETTINGS menu with the BACK .

- The symbol  appears in the status line.

5.1.7 Response of the Internal Resistance Regulation

The internal ceramic resistance between the reference and O₂ electrodes ($R_{ki\ O_2}$) is a function of the sensor temperature, which is constantly regulated for a perfect function of the probe.

NOTICE

The optimum operating point of the KS1D probe lies at a $R_{ki\ O_2}$ of about 20 Ω .

This value must be reached before the first offset calibration or after a probe replacement is triggered.

If the measured $R_{ki\ O_2}$ deviates too strongly from the optimum setpoint value $R_{ki\ S} = 20\ \Omega$. (see Menu 213), the installation situation of the probe must be changed for optimum operation:

$R_{ki\ O_2} > 25\ \Omega$.

- The probe does not become hot enough:
 - The probe was installed in a cold spot and is thus cooled. Determine a new installation site.
 - If necessary, check whether a $R_{ki\ O_2}$ of 20 Ω is reached when it is disassembled. If a too high $R_{ki\ O_2}$ is assumed by the internal resistance regulation, the probe functions outside of its optimum operating point.

$R_{ki\ O_2} < 20\ \Omega$.

- The internal resistance regulation automatically sets the R_{ki} setpoint value to 20 Ω :
 - After 30 minutes in fault-free measurement operation and subsequent offset calibration
 - After 120 minutes in fault-free measurement operation without an offset calibration

5.1.8 Premature Cold Start Termination

Occasionally, it might be necessary to terminate the COLD START prematurely, e.g., after a short-term power failure, but not before a minimum waiting period of 120 seconds has expired.

NOTICE

A premature cold start termination leads directly into measurement operation without an additional prompt. If the probe does not reach its optimum operating point, falsified measured values and, possibly, faults and warnings are the result.

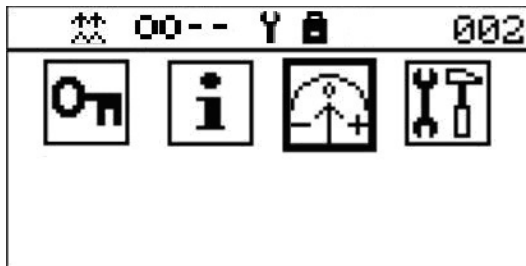

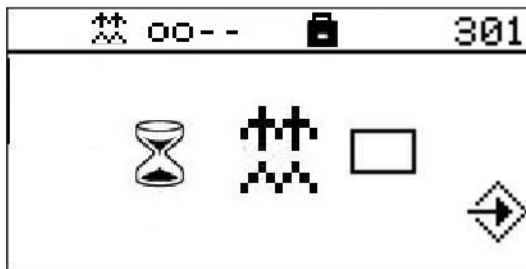

In the main menu, select  for the calibration of the probe.

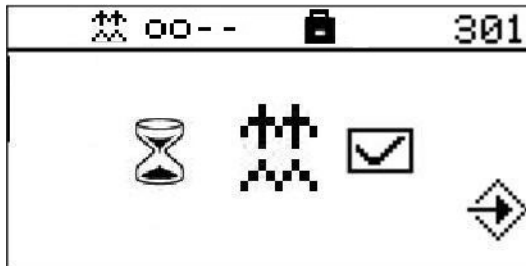

Interrupt the cold start prematurely.



By selecting with the cursor key  and ENTER  the cold start is terminated prematurely.

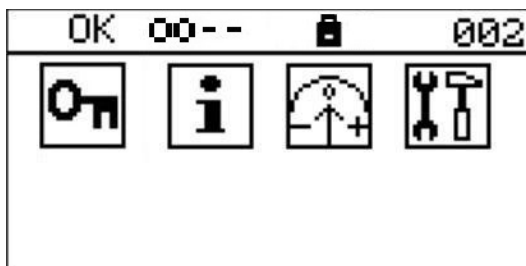

The system returns to the main menu automatically.

5.1.9 Calibrating the Probe

It is recommended to activate MAINTENANCE mode before every running a calibration, see chapter 5.1.6 *Activate/deactivate Maintenance Mode*. This disables probe failures and error conditions. After successful calibration MAINTENANCE mode must be deactivated again.

A correct and regular probe calibration increases measuring precision.

The probes can be calibrated by

- reference measurement or
- test gas

For calibration using a reference measurement, an flue gas analyser is required. The probes can then be calibrated when installed / whilst combustion is taking place.

For the test gas calibration, the KS1D-HT is provided with a test gas connection. It can then be calibrated when installed / whilst combustion is taking place. A testing device is available for the test gas calibration of the KS1D standard (type 656R2000)(see Chapter 5.1 *Checking/Calibrating the KS1D Combination Probe*). Calibration must take place when the probe is disassembled.

The following calibrations must be performed with the probe after commissioning and/or probe replacement:

- 1 Offset calibration (required; see Chapter 5.1.9.1 *Offset Calibration perform to 21 % O₂*)
– Adapts the O₂ measured value to the ambient conditions. In the process, a known environment with 21 vol.% O₂ must be present.
- 2 O₂ calibration (recommended; see Chapter 5.1.2 *Checking/Calibrating the O₂ Electrode*)
– Adapts the O₂ measured value to the operating conditions around a typical operating point.
- 3 CO_e calibration (recommended; see Chapter 5.1.3 *Checking/Calibrating the CO/H₂ Electrode*)
– Adapts the CO_e measured value to the operating conditions of the combustion system.

NOTICE

For good measuring precision, it must be guaranteed that the correct fuel curve is set for the system (e.g., BS1 = light fuel oil EL or BS2 = natural gas) during operation and for calibration with a reference measurement. The factory set fuel curve is natural gas.

NOTICE

For the greatest possible measuring precision, your own burner and fuel specific characteristic curve can be determined and stored. In order for the generally valid fuel curves BS1 and BS2 not to have to be changed, BS3 is unassigned for this purpose.

5.1.9.1 Offset Calibration perform to 21 % O₂

Before offset calibration, check whether Rki O₂ value is equivalent to 20 Ω (see menu 211 and 213 in chapter 5.1.4 *Reading the Measured Values*).

Otherwise, proceed as described in chapter 5.1.7 *Response of the Internal Resistance Regulation*.

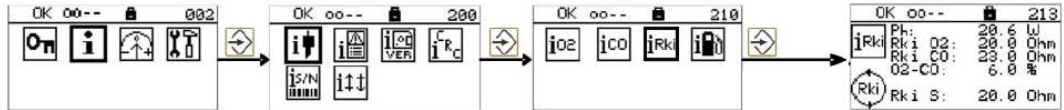

Fig. 5-1 Display R_{ki}

Also check the probe voltage U-O₂. It must be in the range of +10 ... -20 mV.

To perform an offset calibration, the probe must be located in the ambient air and should run for at least 30 minutes in a fault-free measuring mode.

No access level is required!

NOTICE

In case of the KS1D-HT (type 656R2015), the offset calibration can also be performed in an installed state whilst combustion is running. For this purpose, air (dry and oil-free air, instrument air or ambient air) must be fed at connection with a volume of 40 ... 60 l/h for the duration of the calibration.

Activate MAINTENANCE!

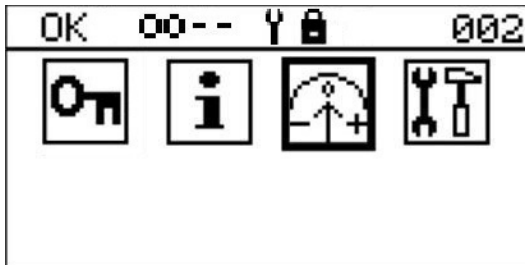

In the MAIN MENU, select  for the calibration of the probe.

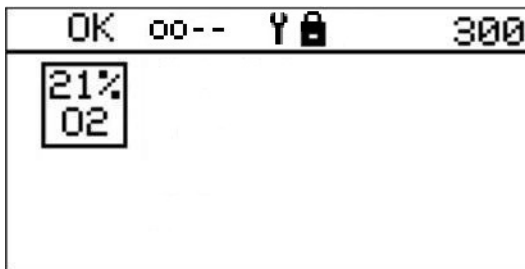

In PROBE CALIBRATION, select  for the offset calibration.

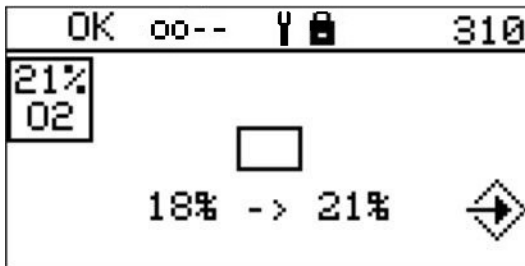

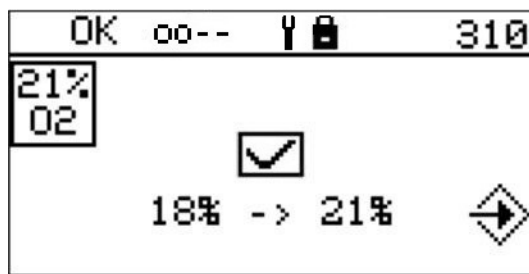

Selecting with the cursor key and ENTER triggers an offset calibration. Within 10 s, confirm the setting with ENTER otherwise the value is not assumed.

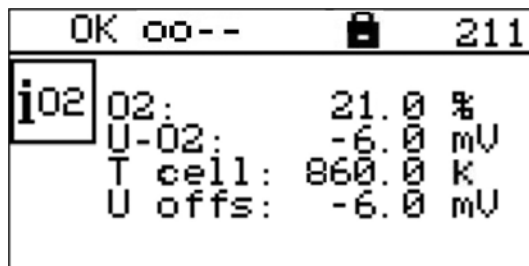

The U_{O_2} value stabilises to values between +10 ... -20 mV.

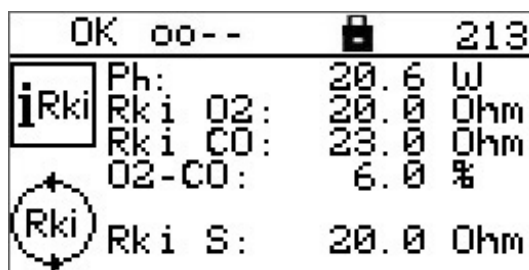

The R_{ki} internal probe resistance values lie between 15 ... 25 Ω .

Display of whether the internal probe resistance regulation is active!

P_h Display of the current heating capacity

$R_{ki} S$ Display of the setpoint value for the internal resistance regulation.

O₂-CO: Evaluates the cross-talk response between the O₂ and CO electrodes. If the influence is too large (>15 %), the sensor signals overwrite each other. This leads to measurement faults and triggers Fault FH007/10 after 30 seconds. A basic influence always exists due to the common GND of the electrodes.

- The offset calibration takes place automatically once triggered
- After a successful calibration, the O₂ value is at 21 vol.% O₂, whilst the CO_e value is at 0 ppm.
- Deactivate **MAINTENANCE MODE**; see Chapter 5.1.6 *Activate/deactivate Maintenance Mode*.

5.1.9.2 Calibrating the O₂ Electrode in the Operating Point

- Activate **Maintenance mode**.

NOTICE

Access level 1 or 2 required!

NOTICE

A correct calibration of the O₂ electrode with reference measurement works in the CO_e content flue gas as well. (from software version V0.106)

The calibration can be performed by reference measurement using an external measuring device or by using test gas at a known O₂ concentration. For KS1D type 656R1015 a special test gas adapter is required (KS1D only).

For the KS1D-HT, a hose connection for calibration gas through which the test gas (40 ... 60 l/h) can be input is available.

A special test gas adapter is not required for this type.

Recommended test gas: 3 vol.% O₂ in N₂.

NOTICE

When performing a reference measurement using an external measuring device, check if the measuring device is measuring wet or dry. In the case of devices with an upstream measuring gas cooler, it always concerns a dry measurement. This also applies to devices which remove the moisture by means of a chemical substance. The KS1D probe measures wet. The difference between a wet to dry measurement is evident from the graphic in the appendix under *11.1 Wet/Dry Measurement Deviations, Conversion Table*.

NOTICE

Calibration / checking with a reference measurement functions only with O₂ values < 15 vol. % and > 1 vol. %.

NOTICE

Do not perform an O₂ calibration with calibration gases ≥ 15 % O₂. Otherwise the calibration values are rejected and the warnings WH003/0 and WH004/0 are indicated.

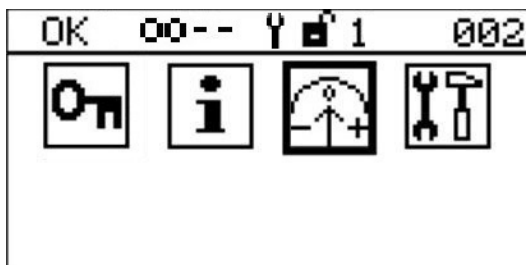

In the Main Menu, select  for probe calibration.

5 Maintenance

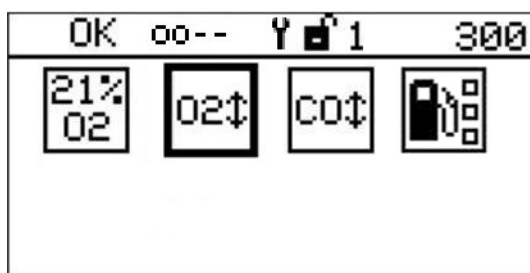

In Probe Calibration, select  for O₂ calibration.

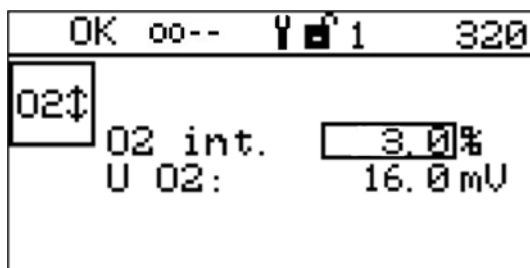

With , , ,  change the O₂ values of the probe.

Within 5 s, confirm the calibration with  otherwise the calibration is not assumed.

- Deactivate **MAINTENANCE MODE**.

5 Maintenance

5.1.9.3 Perform a Calibration of the CO/H₂ Electrode

- Activate maintenance mode.

NOTICE

Access level 1 or 2 required!

The calibration can be performed by reference measurement using an external measuring device or using test gas in combination with a testing device (type 650R1015) of test gas at a known CO_e concentration.

For KS1D type 656R2000, a special adapter for test gas is necessary. (For the required test gas adapter for the KS1D (Type 656R2000), see Chapter 5.1.10 *Checking/Calibrating with Test Gas*).

For the KS1D-HT (Type 656R2015), a hose connection for calibration gas through which the test gas (40 ... 60 l/h) can be input is available.

Recommended test gas: 3 vol.% O₂, 200 ppm CO, 100 ppm H₂, in N₂

CO_e value to be set: 300 ppm

A test gas without O₂ cannot be used for the calibration. The test gas must always contain O₂ in the % area.

NOTICE

Calibration / checking with a reference measurement functions only with CO_e values >100 ppm.

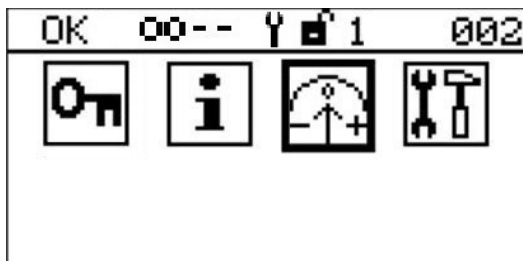

In the main menu, select  for the calibration of the probe.

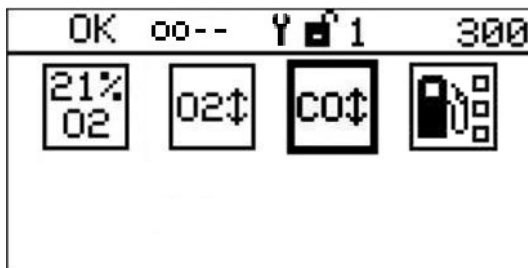

In PROBE CALIBRATION, select  for CO_e calibration.

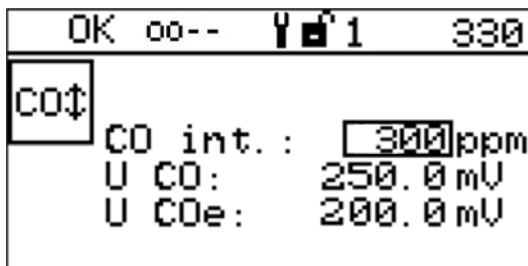

With the keys , , ,  change the CO_e values.

Within 5 s, confirm the calibration with  otherwise the calibration is not assumed.

The probe is now ready for operation.

Deactivate maintenance mode; see Chapter 5.1.6 *Activate/deactivate Maintenance Mode*.

5.1.10 Checking/Calibrating with Test Gas



WARNING!

Danger of burns!

Probe becomes hot during operation.

If the probe is operated when removed, there is a danger of burns on the probe housing.

- ▶ Never lay the probe on flammable material and heat it up.
 - ▶ Wear protective gloves
-

Description of the Testing Device

General Information:

The probe signals are pressure-dependent so they must be tested in a pressure-free environment. The testing device takes this into consideration and guarantees the best results in specific ranges. In exceptional cases, the pressure of the testing device must be adjusted to the pressure of the measuring point through an additional device.

Choose a test gas combination so that O₂ or CO_e content lies in the usual plant specific range and within the specified measuring range of the probe. In standard applications in the combustion technology, O₂ concentration lies at 2-5 vol.% and CO_e concentration lies between 100 ... 500 ppm. The following indicated test gas composition guarantees best results.

Description:

The testing device is a device for the task of testing gases on the probes LS2/KS1/KS1D in standard housing. The probe can be tested or calibrated by means of test gas function.

The testing device can be used lying on the table or plugged into the flue gas channel (*Fig. 5-2 Testing device laying on the table* and *Fig. 5-3 Testing device plugged into flue gas channel*). For gas-tight fixing at the flue gas channel, the probe screw joints (clamping ring/screw cap) can be attached to the plug in nozzle for flue gas channel.

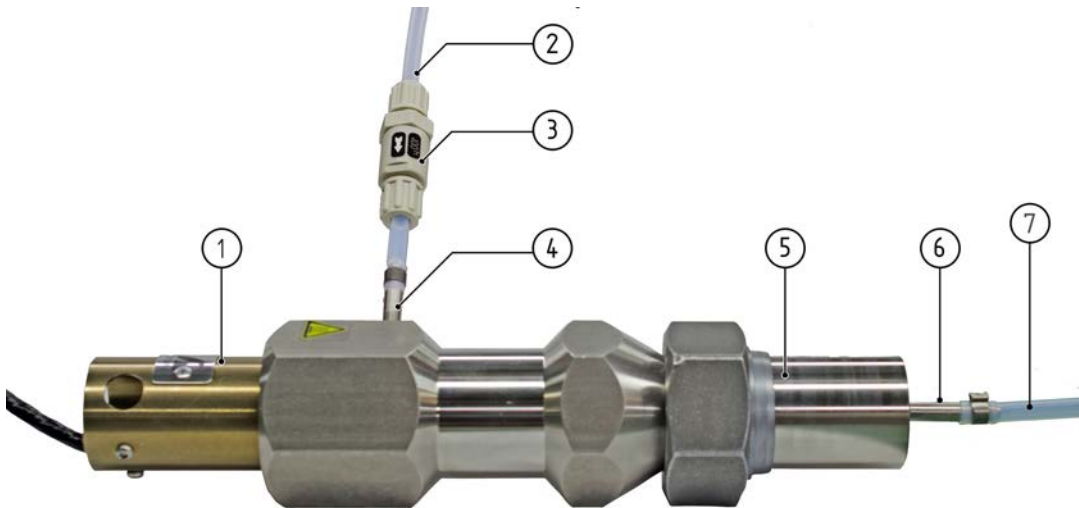

Fig. 5-2 Testing device laying on the table

- 1 Probe LS2, KS1, KS1D in Standard housing
- 2 Hose
- 3 Particle filter
- 4 Test gas connection
- 5 Plug in nozzle for flue gas channel
- 6 Test gas outlet
- 7 Hose



Fig. 5-3 Testing device plugged into flue gas channel

Recommendation:

To check the O₂ electrode, use a test gas with 3 vol. % O₂ in N₂.

NOTICE

It is not possible to calibrate the CO/H₂ electrode using hydrogen free test gas containing CO.

Recommendation:

To check the CO/H₂, use a test gas with 100 ppm H₂, 200 ppm CO, and 3 % O₂ in N₂. Calibrate to 300 ppm.

Test probe

1. Install probe:
Push probe into the testing device until stop.
2. Heat up probe:
A cold probe should be heated up for at least 45 minutes in the installed condition. Should an already heated up probe be installed in the testing device, then wait for 15 minutes.

**CAUTION!**

The testing device with plugged in heated probe would get hot.

Risk of burning!

3. Test gas function:
The test gas connection would be connected to the pressure reducer or the compressed air supply of the test gas bottle using hose or hose clamp (D_i=4; D_a=6 mm (0.236" in)). The corresponding test gas is to be given up with 2 ± 1 bar (pressure behind the bottle pressure reducer). After 2 minutes, the probe calibration and testing can take place.

NOTICE

For test gas usage of 2 bar, test gas pressure lies at 1.6 l/min and increases at 0.6 l/min per bar increase in pressure.

**WARNING!****Risk of poisoning by carbon monoxide!**

Carbon monoxide is a poisonous gas. Inhalation can cause severe poisoning symptoms and can be fatal.

- ▶ Perform the calibration quickly and only in open, well-ventilated rooms, ideally underneath an exhaust hood.
- ▶ Do not open the valve on the test gas cylinder until shortly before calibration and close it immediately after calibration!

4. Calibration/probe testing:
According to table 4, LS2 is to be tested within 2 steps while KS1/KS1D in 3 steps.

5 Maintenance

Testing/ calibration	Description
1 Offset	Offset testing/calibration Compare oxygen values of probe and test gas A. Should the deviation of oxygen value be less than or equal to 0.2 vol.% of 21 vol.% (as shown in parameter 15, internal value O ₂), the probe is fine. Should the deviation of oxygen value be more than 0.2 vol.%, the probe must be calibrated according to the manual.
2 O ₂	O ₂ testing/calibration Compare oxygen values of probe and test gas B. Should the deviation of oxygen value be less than or equal to 0.1 vol.% of 3 vol.%, the probe is fine. Should the deviation of oxygen value be more than 0.1 vol.%, the probe must be calibrated according to the manual.
3 CO/H ₂	CO/H ₂ testing/calibration If the probe reacts to an increase in probe voltage on test gas C, then the probe is fine. If the probe does not react, it has to be changed. Compare CO value of the probe and CO _e -value of test gas C. If CO _e value of the probe lies between 275 ... 375 ppm, the estimation of CO _e value is fine. Otherwise, calibrate a more precise estimation of the probe according to the manual. calibrate on 300 ppm.

NOTICE

CO/H₂ calibration with test gas C has the advantage of determining and compensating the long term drift of sensitivity. The sensitivity of the CO/H₂ electrode usually increases over time → safe direction!

NOTICE

With KS1D HT (order no. 656R2015), the test gas to be tested/calibrated can be connected directly at the hose connection for calibration gas. A special testing device is not necessary. The required test gas quantity lies between 40 ... 60 l/h.

Probe calibrated

Table 4: Test gas matrix for testing or calibrating the respective probe

Functional check/calibration with test gas	Probe		
	LS2	KS1	KS1D
1 → Offset	A	A	A
2 → O ₂	B	B	B
3 → CO/H ₂	C	C	C

Table 5: Test gas composition

Test gas	Composition		
	O ₂ [Vol.%]	CO _e [ppm]	N ₂ [Vol.%]
A	21	0	Rest
B	3	0	Rest
C	3	300	Rest

* CO Equivalent CO_e is the sum of all components in the exhaust gas. In test gases, it is represented by CO and H₂ in proportion of 2:1, e.g. 300 ppm CO_e = 200 ppm CO + 100 ppm H₂.

** In the test gas device, the probe can be calibrated/tested with oil-free pressure air or synthetic air from test gas bottle. In a CO_e-free and defined surrounding, the probe can also be tested/calibrated outside of the test gas device.

5.1.11 Checking/Calibrating with Reference Measurement

- The system must be in operation (ideally at the desired operating point).
- Perform the calibration as described in Chapters 5.1.2 *Checking/Calibrating the O₂ Electrode* and 5.1.9.3 *Perform a Calibration of the CO/H₂ Electrode*.

5.1.12 Simple Function Test of the CO/H₂ Electrode



WARNING!

Danger of burns!

Probe becomes hot during operation.

If the probe is operated when removed, there is a danger of burns on the probe housing.

- ▶ Never lay the probe on flammable material and heat it up.
- ▶ Wear protective gloves

1. Dismantle the probe
2. Fill isopropyl alcohol in a glass (approx. 1 cm)
Alternatively, use brandy/perfume / etc.
3. Hold the probe without the GED upside down into the glass.
Do not immerse!

NOTICE

An additional possibility is to purge the probe with test gas containing CO, NO, H₂, etc. Some ppm are enough.

If the probe is OK, this immediately reacts with a considerable increase in the probe voltage (CO_e value) respective to the probe dynamic response.

5.1.13 Wear-and-Tear Parts of the KS1D Combination Probe

Average life cycle = 2 - 3 years (depending on fuel).

Recommendation:

Exchange the ZrO₂ measuring cell after 5 years at the latest.

A worn measuring gauge could cause errors while calibrating and therefore impede the precision of measurement.

The Combination Probe KS1D type 656R2000 with housing and type 656R2010 without housing can only be replaced completely

.For Combination Probe KS1D HT (high temperature) type 656R2015, a replacement kit is available. Order no. 656R2065.

5 Maintenance

5.2 Settings



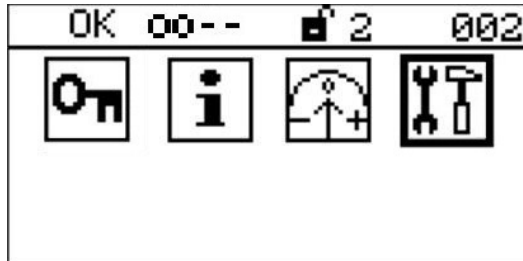



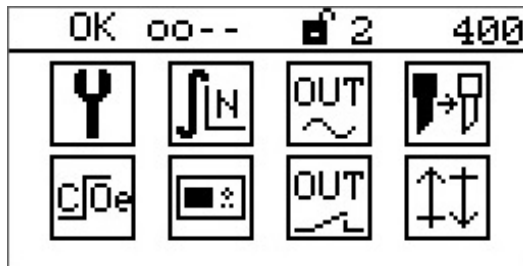

According to which access level you are located, you can make various settings. In access level 2 (Service), all settings can be made.



In the MAIN MENU, select  to make settings.



SETTINGS, offers the following setting possibilities:

-  Maintenance mode (Level 0); see Chapter 5.2.1 *Maintenance Mode*
-  Filter time of the measured values (Level 0).
-  Analogue outputs (Level 1); see Chapter 8.1.3 *Conversion of the Output Range via the User Interface*
-  Probe replacement (level 1).
-  CO_e response threshold (Level 2).
-  Display (Level 0).
-  Limit values (Level 1).
-  Digital outputs (Level 2).

5.2.1 Maintenance Mode

In "SETTINGS", select  (see Chapter 5.1.6 *Activate/deactivate Maintenance Mode.*)

5.2.2 Filter Time

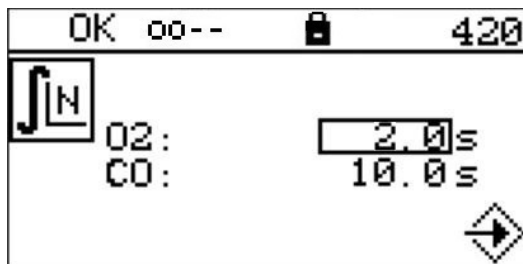

Filter time of the measured values:
No access level is required to make this setting.
Time over which the measured values are determined (in an integrated manner).
Factory setting:
O₂ measured value 2 seconds
CO_e measured value 10 seconds

5 Maintenance

5.2.3 Analogue Outputs

In "SETTINGS", select  for analogue outputs (see Chapter 8.1.3 *Conversion of the Output Range via the User Interface*).

5.2.4 Replacing a Probe

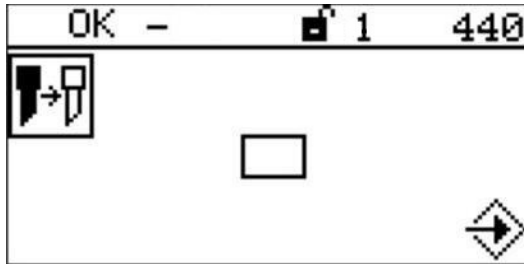

Probe replacement:

A minimum of access level 1 is required for triggering.

(See Chapter 5.2.4 *Replacing a Probe*.)

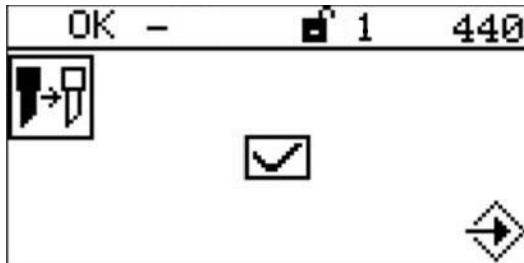

5.2.5 Display

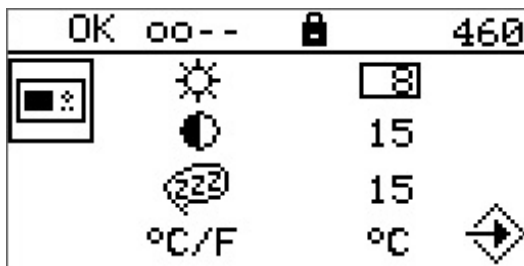

Display (no access level is required):

Brightness

Contrast

Time in seconds until the background lighting is shut OFF

Switch from °C to °F and vice versa

5.2.6 Limit Values

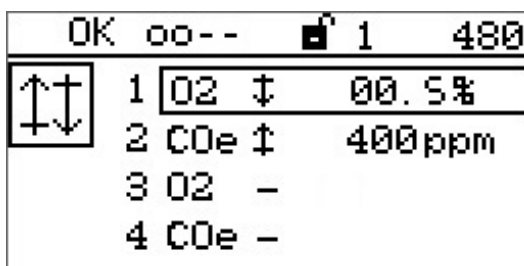

Limit values

Proceed with the  key.

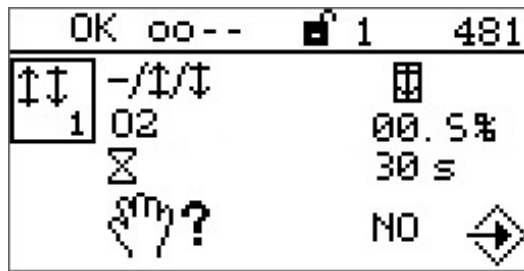

Control of the entry with the following key sequence:



-/↑/↓	- Limit value off ↑ Monitoring of exceeding ↓ Monitoring of undershooting
02	Setting of limit value
∑	Setting of trigger time of limit value
hand?	NO - limit value resets automatically YES - manual acknowledgement of limit value required (see Chapter 4.4.2 <i>Main Menu - Information</i>)

If a limit value is undershot/exceeded, this is indicated in the status line by a down/up arrow (see Chapter 4.3 *Status Line*).

In addition, the following message appears on the display:

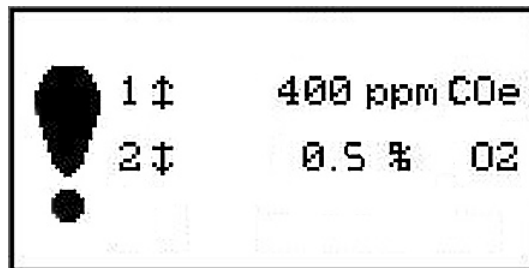

Key returns to the main display

Limit value 1:

- Factory setting: Exceeding of 400 ppm CO_e, 60 s

Limit value 2:

- Factory setting: Undershooting of 0.5% O₂, 30 s

The exceeded/undershoot value starts blinking in the main display 001.



Use the arrow key to change back from display 001 to the appropriate indication of the limit values. If the limit value must be quitted by hand a hand symbol is shown in the display. Use the ENTER key to quit the limit value.

6 Correcting Faults

6 Correcting Faults

6.1 Faults and Warnings

Faults and warnings are indicated by displaying the according fault and warning codes. Additionally faults are displayed by the red blinking of the "Enter" button.

With the BACK  you reach the main window 001. If the fault/warning is still active it will be displayed by a blinking symbol  in the status line of the screen. With the arrow key  you can reach the fault/warning code from the main screen. A fault/warning is displayed until the according value reaches a normal state. Faults and warnings can be indicated by an optional digital output module.

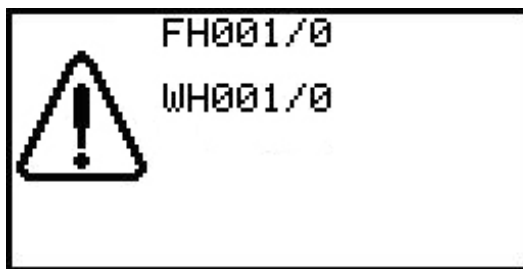

- F** Fault
- W** Warning
- H** Main processor
- 001** Fault number
- /1** Fault probe/probe voltage trigger 1

NOTICE

With internal or not assignable faults, read data set with LSB Remote Software and send it to LAMTEC for analysis!

6 Correcting Faults

6.1.1 Faults

Fault no.	Fault text
002 (HP) 102 (ÜP)	Probe heating fault
/1	The heater is short-circuited or has a high resistance; tolerance time of 10 seconds
	<p>Help:</p> <ul style="list-style-type: none"> - Check the wiring. LT3 Term. 13 and 14 → disconnect the probe - probe heating at LT3-Ex or in SAK and measure the heater resistance between wire nos. 13 and 14 on the probe side. Resistance approx. 9 ... 10 Ω in heated state. - If not OK, exchange the probe and restart. - If OK, the fault presumably lies on the mainboard of LT3. If the lines of the probe heating and probe signal are mixed up during connection (possible in the case of the SAK wiring), the mother board is destroyed. Disconnect the probe and measure the heating voltage: approx. 11V
/2	Heating power more than 15 s outside of the permitted range (8W ... 25 W)
	<p>Help:</p> <p>Installation site too hot: the heating capacity cannot be further reduced (current actual value of $R_i < 20 \Omega$) to reached the setpoint value of the internal resistance R_{ki} of 20 Ω or</p> <p>Installation site too cold: the heating capacity cannot be further increased (current actual value of $R_i > 20 \Omega$) to reached the setpoint value of the internal resistance R_{ki} of 20 Ω. Check the value of the internal resistance R_{ki} in the display.</p> <ul style="list-style-type: none"> - Trigger the probe exchange and restart the probe so that the R_{ki} of 20 Ω can be learnt again. - Check the system temperature at the installation site. - Check the probe when removed if pertinent. - Exchange → the worn probe if pertinent. - As a follow-up fault, 002/3 Heater R_i outside of 5 ... 15 Ω might be displayed.
/3	Heater R_i outside of 5 ... 15 Ω Internal resistance of heater outside of the interval 5 Ω ... 15 Ω
	<p>Help:</p> <p>Installation site too hot: the heating capacity cannot be further reduced (current actual value of $R_i < 20 \Omega$) to reached the setpoint value of the internal resistance R_{ki} of 20 Ω. Check the value of the internal resistance R_{ki} in the display.</p> <ul style="list-style-type: none"> - Trigger the probe exchange and restart the probe so that the R_{ki} of 20 Ω can be learnt again. - Check the system temperature at the installation site. - Check the probe when removed if pertinent. - Exchange → the worn probe if pertinent. <p>As a follow-up fault, 002/2 Heating capacity outside of permissible interval (8 W ... 25 W) for longer than 15 s might be displayed.</p>

6 Correcting Faults

/4	OFF current too high
/5	Heating control circuit open Heater controller at limit stop for longer than 30 seconds. Help: Check wiring between probe and LT3 (check probe signals terminals 10/11/12)
/6	Temperature of the O ₂ sensor too high (R _{ki} -O ₂ too low) For longer than 10 seconds, R _{ki} -O ₂ is under 10 Ω Heater R _i outside of 5 Ω ... 15 Ω Internal resistance of heater outside of the interval 5 Ω ... 15 Ω
/7	Temperature of the CO sensor too high (R _{ki} -CO too low) For longer than 10 seconds, R _{ki} -CO is under 10 Ω
003 (HP) 103 (ÜP)	Internal fault of analogue signal processing Device defective - Contact the manufacturer. Specify the trigger for diagnostic purposes.
004 (HP) 104 (ÜP)	Internal resistance of ceramics of the O₂ electrode
/1	R _{ki} O ₂ too high. Internal resistance of ceramics of O ₂ for LT3-F over 50 Ω, and/or for LT3 over 100 Ω, tolerance time of 30 seconds.
/2	R _{ki} O ₂ too low. Internal resistance of ceramics of O ₂ under 10 Ω, tolerance time of 30 seconds.
	Help: If R _{ki} -O ₂ for LT3-F over 50 Ω, and/or for LT3 over 100 Ω, then - Probe too cold. - Internal resistance regulation not active or incorrect setpoint value. - The probe is stuck in a cold spot and the heating capacity does not suffice. Look for a new installation position. - Flow speed too high. - Heating defective and probe cold. - Sensor breakage. - Check wiring between probe and LT3 (signal terminals 10/11/12) If R _{ki} -O ₂ under 10 Ω, probe is too hot, internal resistance regulation is not active, or incorrect setpoint value. The optimum operating point (setpoint value) lies at 20 Ω.
005 (HP) 105 (ÜP)	Internal resistance of ceramics of the CO/H₂ electrode
/1	R _{ki} -CO too high. Internal resistance of ceramics of CO for LT3-F over 50 Ω, and/or for LT3 over 100 Ω, tolerance time of 30 seconds.
/2	R _{ki} -CO too low. Internal resistance of ceramics of O ₂ under 10 Ω, tolerance time of 30 seconds.

6 Correcting Faults

	<p>Help: If R_{ki-CO} for LT3-F over 50 Ω, and/or for LT3 over 100 Ω, then</p> <ul style="list-style-type: none"> - Probe too cold. - Internal resistance regulation not active or incorrect setpoint value. - The probe is stuck in a cold spot and the heating capacity does not suffice. <p>Look for a new installation position.</p> <ul style="list-style-type: none"> - Heating defective and probe cold. - Sensor breakage. <p>If R_{ki-CO} under 10 Ω, then probe too hot.</p> <ul style="list-style-type: none"> - Internal resistance regulation not active or incorrect setpoint value. <p>The optimum operating point (setpoint value) lies at 20 Ω</p>
007 (HP) 107 (ÜP)	<p>Probe insulation Device or probe defective. Contact the manufacturer and specify the trigger for diagnostic purposes.</p>
	<p>Help:</p> <ul style="list-style-type: none"> - Remove the probe and check it in ambient air. - Check the wiring between LT3 and probe (sensor signal and terminals 10/11/12) - Probe and LT3 at the same potential? - Exchange the probe.
008 (HP) 108 (ÜP)	<p>Intern fault: measured value comparison HP/UP Device defective; contact the manufacturer and specify the trigger for diagnostic purposes.</p>
014 (HP) 114 (ÜP)	<p>Write the data record</p>
015 (HP) 115 (ÜP)	<p>Parameter/EEPROM fault Device defective. Contact the manufacturer and specify the trigger for diagnostic purposes.</p>
016 (HP) 116 (HP)	<p>Internal fault/self tests Device defective. Contact the manufacturer and specify the trigger for diagnostic purposes.</p>

6 Correcting Faults

6.1.2 Warnings

Warning no.	Warning text
001 (HP) 101 (ÜP)	O₂ offset voltage in the air too large or too small
/1 - 29999	Trigger value of the O ₂ offset voltage in the air (x0.1 mV)
002 (HP) 102 (ÜP)	CO offset voltage in the air too large or too small
/1 - 29999	Trigger value of the CO offset voltage in the air (x0.1mV)
003 (HP) 103 (ÜP)	O₂ temperature too large or too small, was not assumed invalid calibration (p. ex. with calibration gas >14,9 vol % O ₂). The new O ₂ temperature is not accepted. The O ₂ measurement remains/will be improper.
/1 - 29999	Trigger value of the O ₂ temperature (x0.1 K)
004 (HP) 104 ÜP	CO temperature too large or too small, was not assumed invalid calibration (p. ex. with calibration gas >14,9 vol % O ₂). The new CO temperature is not accepted. The CO _e value remains/will be improper.
/1 - 29999	Trigger value of the CO temperature (x0.1 K) Help: When calibrating the O ₂ electrode in CO containing flue gas the O ₂ sensors' Kelvin value moves outside the permissible range (< 800 ... >1200 K). The warning WH004 or WH104 is indicated → CO temperature is too high/too low. The calibration have to be repeated on another point of O ₂ without CO in the flue gas.
005 (HP) 105 (ÜP)	CO scaling
/1	CO value not assumed, CO setpoint value too small
/2	CO value not assumed, division by zero
/3	CO value not assumed, calibration scaling factor outside of the valid range
	Help: CO sensor worn/poisoned. Exchange the probe.
/4	CO value not assumed, value is zero
010 (HP) 110 (ÜP)	For LT3-F: Internal resistance of ceramics of the O₂ electrode over 45 Ω For LT3: Internal resistance of ceramics of the O₂ electrode over 80 Ω
/0 - 65535	Trigger value of current internal resistance (x0.1 Ω), tolerance time of 3 seconds.
011 (HP) 111(ÜP)	For LT3-F: Internal resistance of ceramics of the CO electrode over 45 Ω For LT3: Internal resistance of ceramics of the CO electrode over 80 Ω
/0 - 65535	Trigger value of current internal resistance (x0.1 Ω), tolerance time of 3 seconds.
016 (HP) 116 (ÜP)	Internal warning

6 Correcting Faults

Warning no.	Warning text
/1	<p data-bbox="635 286 1284 347">Serial number, customer ID or service password reset. Contact the manufacturer.</p> <div data-bbox="635 369 1165 638">A pixelated warning display. On the left is a triangle with a curved line above it. To the right is the number '2102'. Below the triangle is the text '00000000XX'. To the right of this text is a large 'X'.</div> <p data-bbox="635 645 1292 678">Display if customer ID in LT3 and UI do not correspond.</p>

6 Correcting Faults

6.1.3 Call of the Fault History

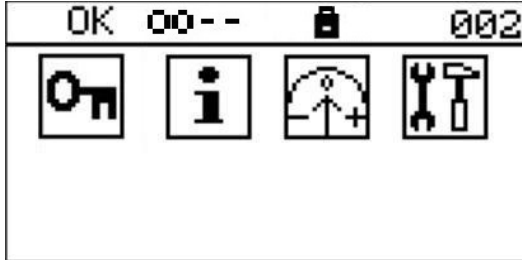

In the main menu, select  for information.

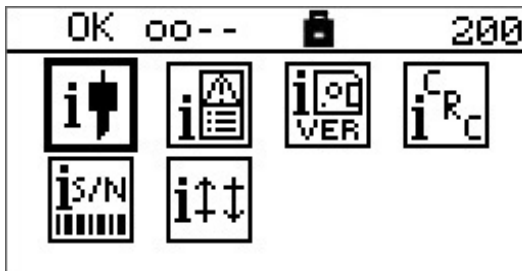

In "Information," select  for the fault history.

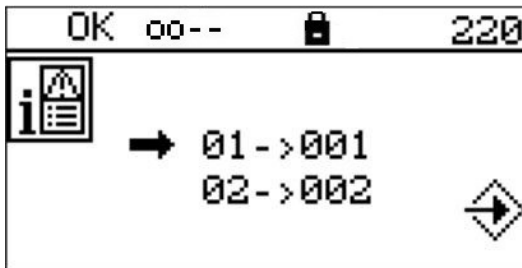

Fault history

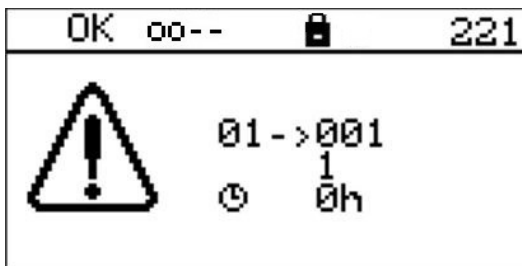

01 Number of the entry

001 Fault number of the main processor
If the fault number is displayed as "101" (+100), there is a fault in the monitoring processor.

1 Trigger 1

0h Occurs in case of ... Operating hours

For fault numbers, see Chapter 6.1.1 *Faults*.

7 Decommissioning

7.1 Decommissioning

7.1.1 Protection Against Emissions from Gas Carrying Channels

Recommendation in case of breaks in operation:

- With longer breaks in operation, in excess of 3 months, switch off the measuring system.
- Removal prevents damage to the probe.
- In the case of briefer breaks in operation, it is recommended that you continue to allow the measuring system to run.

The KS1D Combination Probe is fitted directly to the gas-carrying channel via the probe installation fitting (PIF). If the KS1D Combination Probe or the probe installation fitting (PIF) are dismantled, depending on the plant but particularly in the case of excess pressure, aggressive and / or hot gas can seep out of the channel and pose a serious health hazard to an unprotected operator if suitable safety measures have not been taken previously.



WARNING!

Risk of burning due to hot gases!

In the case of excess pressure and temperatures in excess of 200 °C in the gas channel, gases could escape when dismantling the KS1D Combination Probe or the probe installation fitting (PIF).

- ▶ Before opening, shut down the system.
- ▶ Wear suitable protective clothing and a protective mask.
- ▶ Fix respective warning information in close proximity to the mounting site.
- ▶ Immediately seal the opening again.

The LT3 Lambda Transmitter and the KS1D Combination Probe are a high-quality, electronic measuring system. It therefore requires careful handling in all situations - decommissioning, transport and storage.

NOTICE

Do not switch off the LT3 Lambda Transmitter as long as the KS1D Combination Probe is mounted. Not even if the associated plant has been brought to a standstill. Residual gases will cause corrosion and could damage system components.

- ▶ Do not store the device outside without any protection!
- ▶ When uninstalling, protect the ends of cables and the connectors from corrosion and soiling. Corroded connectors can cause malfunctions.
- ▶ Always store in a dry location and, if possible, keep in the original packaging.
- ▶ If possible, always transport in the original packaging.

NOTICE

The KS1D Combination Probe is capable of being stored in a dismantled state. This also applies if a KS1D Combination Probe has already been in operation once.

8 Options

8.1 Analogue Outputs via LSB Module Current, alternative Voltage, LSB address 19

8.1.1 Functional Description

- Current module: 4 analogue outputs 0/4 ... 20 mA
- Voltage module: 4 analogue outputs 0/2 ... 10 VDC
- Possible to quickly wire several modules by means of strapping plugs

The LSB modules are universally applicable output modules, which are controlled via the LSB SYSTEM BUS. In the process, the module is triggered by an adjustable address (1 - 99). The statuses of the outputs are transferred in the data bytes. If an analogue output module with the same address exists in the system, the voltage / current measured there is shown on the respective output.

NOTICE

All outgoing lines from the LSB module must be screened. The screens must be applied to the PE rail as short as possible.

NOTICE

The termination resistor (120 Ω) **must** be installed and activated on the first and the last BUS device.

Avoid transmission line!

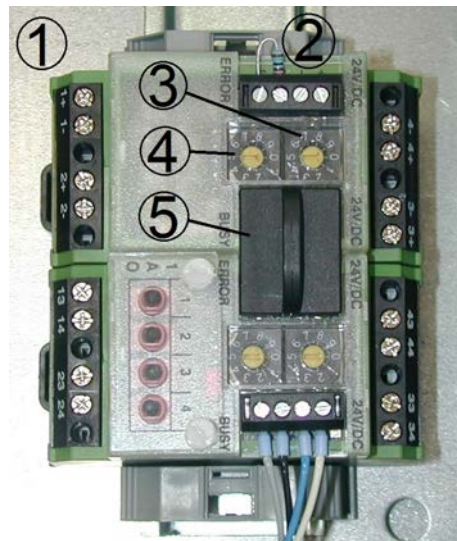

- 1 Analogue output module
- 2 LSB terminal resistance, 120 Ω
- 3 Rotary switch for setting the tens LSB address
- 4 Rotary switch for setting the ones LSB address
- 5 Jumper plug

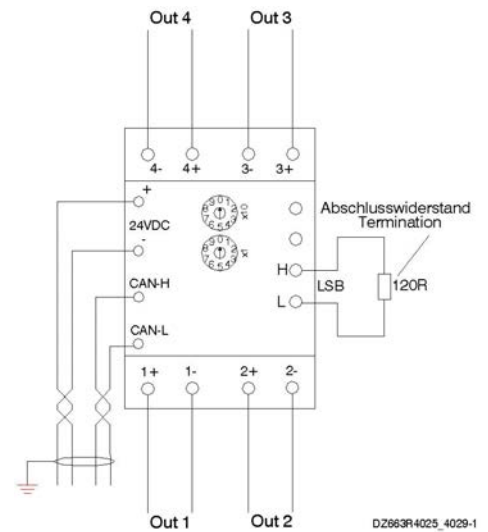

Terminal assignment:

- | | |
|----------------|---|
| 1+ / 1- | Analogue output 1 |
| 2+ / 2- | Analogue output 2 |
| 3+ / 3- | Analogue output 3 |
| 4+ / 4- | Analogue output 4 |
| 24 VDC | Voltage supply for LT3 Terminals 77-/78+ |
| CAN H/L | LAMTEC SYSTEM BUS for LT3 Terminals 74 H/75 L |

8.1.2 Factory Setting of Analogue Outputs via LSB Module

The module is activated at the factory.

In case of a later installation or exchange, the LSB address 19 must be set on the module using only 2 rotary switches.

Analogue output 1 (O₂ measured value)

- Setting range → adjustable between 0 ... 25 % O₂
- Factory setting: 0 ... 10 vol.% O₂ → 4 ... 20 mA

Analogue output 2 (CO_e measured value)

- Setting range → adjustable between 0 ... 30,000 ppm
- Factory setting: 0 ... 1,000 ppm → 4 ... 20 mA

Analogue outputs 3 and 4 are currently deactivated at the factory and/or reserved for other values, such as flue gas temperature and efficiency.

8.1.3 Conversion of the Output Range via the User Interface

Access level 1 required.

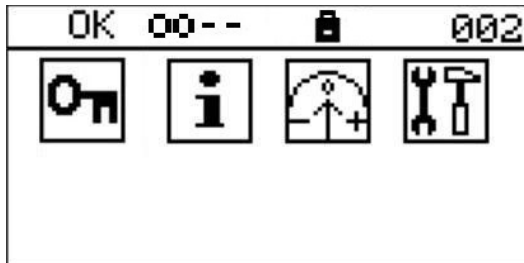

In the main menu, select to make settings.

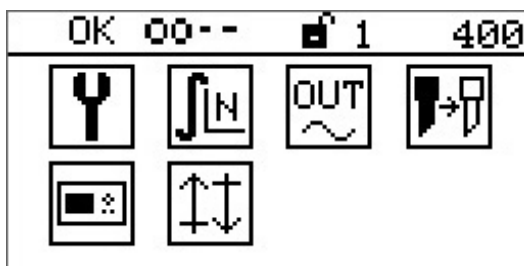

In "SETTINGS", select for analogue outputs.

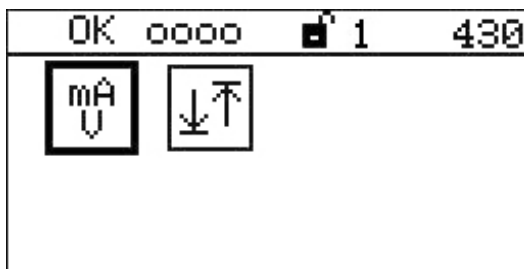

Analogue outputs offer setting possibilities for

- current range or voltage range.
- Output range.

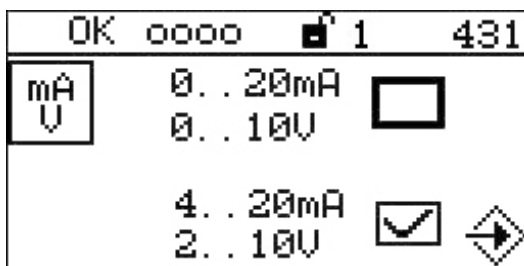

Selection of the current or voltage range according to module.

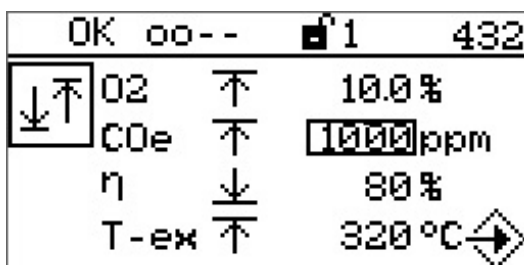

Output ranges for:

- O₂ = O₂ measured value
- CO_e = CO_e measured value
- η = efficiency
- T-ex = flue gas temperature

8.2 Digital Outputs via LSB Module, LSB Address 03 and 51

8.2.1 Functional Description

- 4 relay outputs 250 VAC, 6 A.
- Possible to quickly wire several modules by means of jumper plugs.
- The relay outputs are activated manually using switches.

LSB modules are universally applicable output modules for DIN rail mounting. They are actuated via the LSB. The module is addressed via a settable address (1 ... 99). The data bytes convey whether data is required or commands are to be executed.

NOTICE

All outgoing lines from the LSB module must be screened. The screens must be applied to the PE rail as short as possible.

NOTICE

The termination resistor (120 Ω) **must** be installed and activated on the first and the last BUS device.

Avoid transmission line!

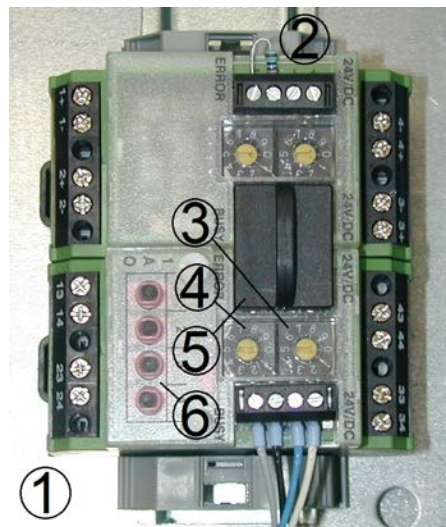

- 1 Digital output module
- 2 LSB terminal resistance 120 Ω
- 3 Rotary switch for setting the tens LSB address
- 4 Rotary switch for setting the ones LSB address
- 5 Jumper plug
- 6 Manual activation

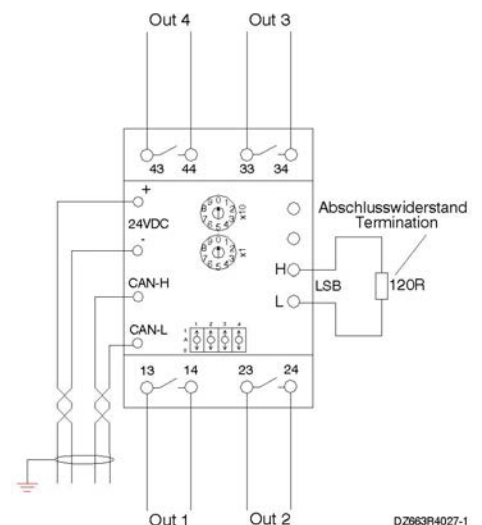

Terminal assignment:

- | | |
|----------------|---|
| 13/14 | Relay output 1 |
| 23/24 | Relay output 2 |
| 33/34 | Relay output 3 |
| 43/44 | Relay output 4 |
| 24 VDC | Voltage supply for LT3 Terminals 77-/78+ |
| CAN H/L | LAMTEC SYSTEM BUS for LT3 Terminals 74 H/75 L |

8.2.2 Factory Setting of the Digital Outputs

The LSB module for digital outputs 1 ... 4 is activated at the factory. In case of a later installation or exchange, the **LSB address 03** must be set on the module using only 2 rotary switches.

Digital output 1 Term. 13/14	Locked faults
Digital output 2 Term. 23/24	Warning
Digital output 3 Term. 33/34	Limit value 1 (exceeding of 400 ppm CO _e , 60 s)
Digital output 4 Term. 43/44	Limit value 2 (undershooting of 0.5 vol. % O ₂ , 30 s)

The LSB module for digital outputs 5 ... 8 is activated at the factory. In case of a later installation or exchange, the **LSB address 51** must be set on the module using only 2 rotary switches.

Digital output 5 Term. 13/14	Calibration
Digital output 6 Term. 23/24	Cold start
Digital output 7 Term. 33/34	Measure
Digital output 8 Term. 43/44	Warning

8 Options

8.2.3 Settings

Only in access level 2 (Service)

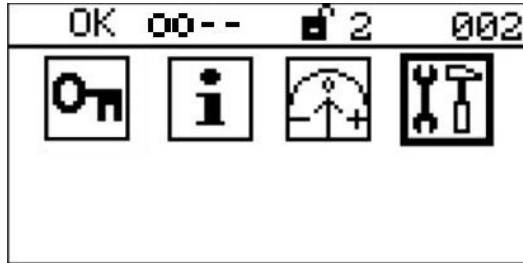

In the MAIN MENU, select  to make settings.

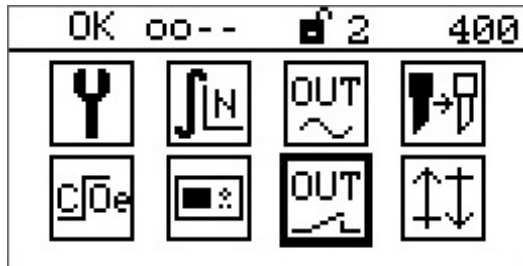

In SETTINGS select  for digital outputs.

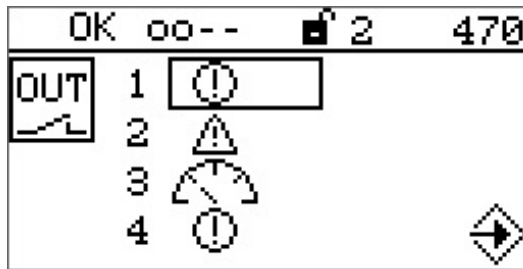

In DIGITAL OUTPUTS select 1, 2, 3, or 4 to allocate the desired trigger to the respective digital output.

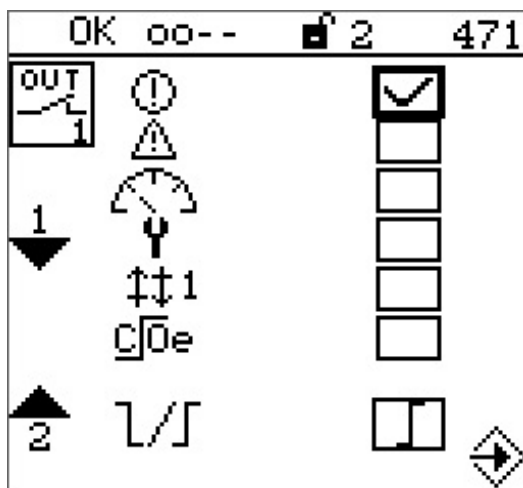

 Warning

 locked fault

 Calibration

 Maintenance

 Limit value

Limit value 1, digital output 1 only

Limit value 2, digital output 2 only

Limit value 3, digital output 3 only

Limit value 4, digital output 4 only

 CO edge signal

 Operating current (relay switches when the trigger is active)

 Closed-circuit current (relay switches when the trigger is not active)

8.2.4 Diagnosis of the Digital Outputs

4 LEDs above the switches indicate the switching state of the digital outputs.

NOTICE

Manual activation of the relay outputs:

Position 1 → output contact always closed

Position A → output contact switches via LSB

Position 0 → output contact always open

8.3 Digital Inputs via the LSB Module, LSB Address 11 and 55

8.3.1 Functional Description

- 4 floating digital inputs per module
- 8 digital inputs possible (2 modules)
- The digital inputs are activated manually using switches.

LSB modules are universally applicable output modules for DIN rail mounting. They are actuated via the LSB. The module is addressed via a settable address (1 ... 99). The data bytes convey whether data is required or commands are to be executed.

NOTICE

All outgoing lines from the LSB module must be screened. The screens must be applied to the PE rail as short as possible.

NOTICE

The termination resistor (120 Ω) **must** be installed and activated on the first and the last BUS device.

Avoid transmission line!

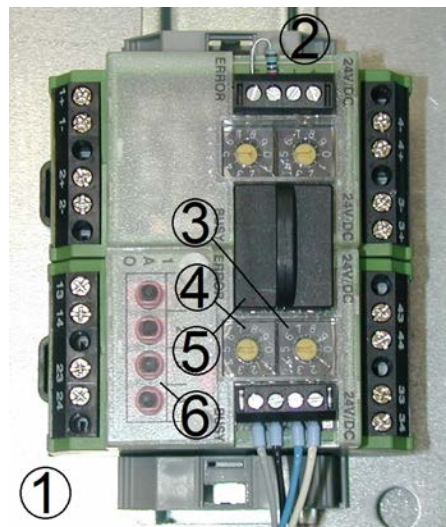

- 1 Digital input module
Input 1 ... 4, address 11
Input 5 ... 8, address 55
- 2 LSB terminal resistance, 120 Ω
- 3 Rotary switch for setting the tens LSB address
- 4 Rotary switch for setting the ones LSB address
- 5 Jumper plug
- 6 Manual activation

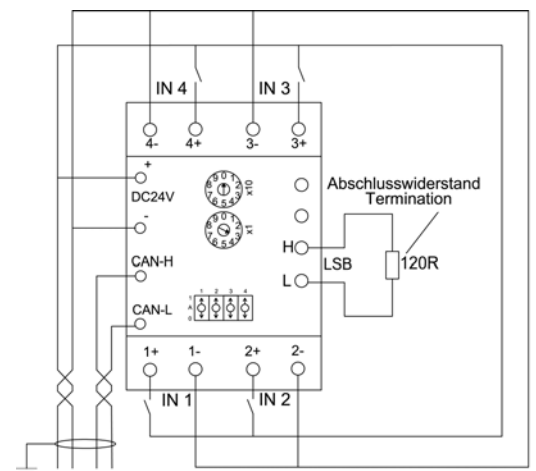

DZ663R4028-*

Terminal assignment:

- | | |
|----------------|---|
| 1+/1- | Digital input 1 |
| 2+/2- | Digital input 2 |
| 3+/3- | Digital input 3 |
| 4+/4- | Digital input 4 |
| 24 VDC | Power supply |
| CAN H/L | for LT3 Terminals 77-/78+
LAMTEC SYSTEM BUS
for LT3 Terminals 74 H/75 L |

8.3.2 Factory Settings of the Digital Inputs

Digital input 1	Trigger OFFSET CALIBRATION
Digital input 2	RESET FAULT
Digital input 3	SWITCHOVER to CO _e curve FUEL 1
Digital input 4	DEACTIVATION LIMIT VALUE 1 ... 4
Digital input 5	RESET LIMIT VALUE 1 ... 4
Digital input 6	SWITCHOVER to CO _e curve FUEL 3
Digital input 7	SWITCHOVER to CO _e curve FUEL 4
Digital input 8	DEACTIVATION CALIBRATION

NOTICE

Manual activation of the relay outputs:

Position 1 → input always activated

Position A → input switches via external contact with 24 VDC

Position 0 → input always deactivated

8.3.3 Diagnosis of the Digital Inputs

4 LEDs above the switches indicate the switching state of the digital outputs.

8 Options

8.4 Technical Data for HART Module

Setting of LSB address not necessary.

8.4.1 Functional Description

- Current module: 2 analogue outputs 0/4 ... 20 mA
- HART communication (SLAVE) via analogue output 1

NOTICE

All outgoing lines from the HART module must be screened. The screens must be applied to the PE rail as short as possible.

NOTICE

The termination resistor (120 Ω) **must** be installed and activated on the first and the last BUS device.

Avoid transmission line!

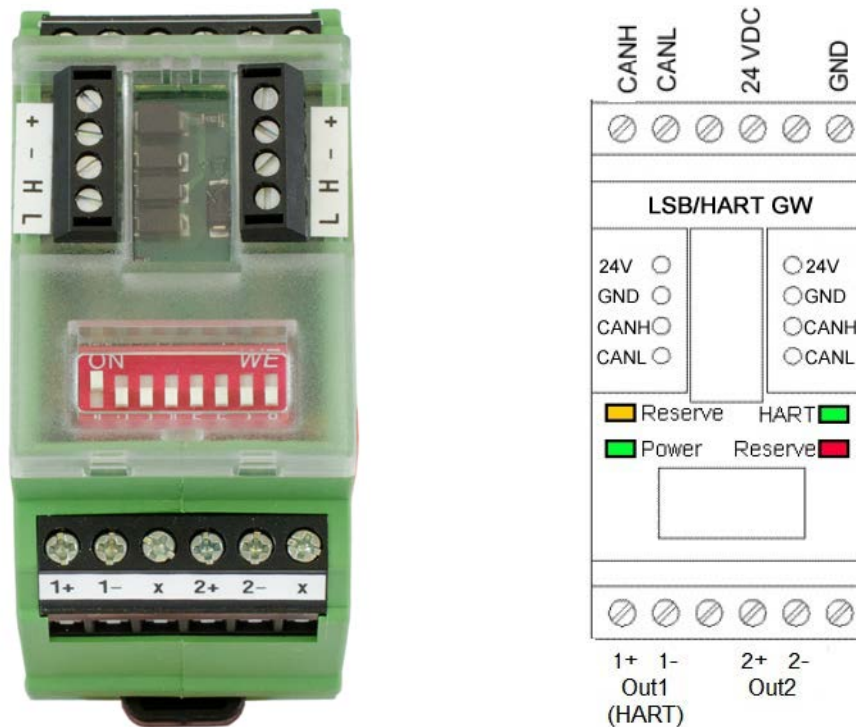

Terminal assignment:

- | | |
|---------|--|
| 1+ / 1- | Analogue output 1 and HART communication (SLAVE) |
| 2+ / 2- | Analogue output 2 |
| 24 VDC | Voltage supply for LT3 Terminals 77-/78+ |
| CAN H/L | LAMTEC SYSTEM BUS for LT3 Terminals 74 H/75 L |

8 Options

8.5.2 LEDs

PBM100 has 4 LEDs which are connected as described below:

LED	Colour	Description
PWR	green	ON: Module working in normal mode = fully initialised and without any fault.
CAN	green	OFF: No communication or CAN BUS error Blinking with 2 Hz: Errors (optional, if a CAN warning is detectable) ON: CAN is ready.
PB	green	OFF: no communication via PROFIBUS DP ON: communication without error via PROFIBUS DP
ERR	red	OFF: no errors ON: PBM100 Initialisation incomplete or not yet successfully completed or CAN message missing for more than 3 s.

8.5.3 PROFIBUS DP Communication

Specification of the PB master input data

In the following, the input data that the PBM transfers to the master is specified:

Byte position *	Designation	Configuration
1, 2	CO _e actual value	CO _e display value, uint 16 value in ppm
3, 4	CO _e actual value status	Measure value status (CO/O ₂) and edge information (see the Bit encoding CO/O ₂ actual value status in Chapter 8.5.4 <i>Communication Appendix</i>)
5, 6	O ₂ actual value	O ₂ display value, uint16 value in [ppm], for status, see CO _e
7, 8	CO sensor voltage raw	Electrode voltage 1, int16 value in [1mV]
9, 10	O ₂ sensor voltage raw	Electrode voltage 2, int16 value in [1mV]
11, 12	Probe voltage U _{CO_e}	Effective CO voltage, int16 in [0.1mV]
13, 14	LT3 status	Device status bit-encoded
15, 16	Warning word 1	LT warnings bit-encoded, Bit [0 ... 15] for each warning 1 ... 16
17, 18	Warning word 2	LT warnings bit-encoded, Bit [16 ... 31] for each warning 17 ... 32
19, 20	Fault word 1	LT faults bit-encoded, Bit [0 ... 15] for each warning 1 ... 16
21, 22	Fault word 2	LT faults bit-encoded, Bit [16 ... 31] for each warning 17 ... 32

* Byte-number-wise from 1

Specification of the PROFIBUS master output data

The following shows the assignment of the output data received by the PBM from the PROFIBUS master.

NOTICE

If the PROFIBUS module is used with a BT300 with software version 3.3 or older, only selected LSB digital modules can be used (see the LSB module ID table in Chapter 8.5.4 *Communication Appendix*).

Byte position *	Designation/configuration
1, 2	Fault/warning reset Execution for change byte 1, 2 of 0x55AA → 0xAA55 0xAA55 → 0x55AA
3	ID (number) of digital module 1 ...16**
4	Bit encoding of the digital outputs to be set Bit [0 ... 3] →digital outputs 1 ... 4 (see the Bit encoding status of the digital outputs of the LSB module table in Chapter 8.5.4 <i>Communication Appendix</i>).

* Byte-number-wise from 1

** Here, specify the number of the digital module (1 ... 16), and set the address on the LSB module according to the number and LSB family; cf.

8.5.4 Communication Appendix

Bit encoding status of the digital outputs of the LSB module

Digital outputs	Active (bit encoding)
1	0x01
2	0x02
3	0x04
4	0x08

ID of LSB modules – address to be set on the rotary switches

LSB module no.	LSB family				BT300 support Until Release 3.3
	1	2	3	4	
Digital module 1	3	2	1	0	✗
Digital module 2	7	6	5	4	✗
Digital module 3	11	10	9	8	✗
Digital module 4	15	14	13	12	✗
Digital module 5	18	18	17	16	✗
Digital module 6	23	22	21	20	✗
Digital module 7	27	26	25	24	✗

8 Options

LSB module no.	LSB family				BT300 support Until Release 3.3
	1	2	3	4	
Digital module 8	31	30	29	28	✗
Digital module 9	35	34	33	32	✗
Digital module 10	39	38	37	36	✗
Digital module 11	43	42	41	40	✗
Digital module 12	47	46	45	44	✓
Digital module 13	51	50	49	48	✓
Digital module 14	55	54	53	52	✓
Digital module 15	59	58	57	56	✗
Digital module 16	63	62	61	60	✗

Bit encoding of CO/O₂ actual value status

Active (bit encoding)	Explanation
0x0001	CO edge not triggered
0x0002	CO edge triggered/undershot
0x0001/0x0002 Not set	Edge signal not determined by sending device
0x0200	Underrun
0x0400	Overflow
0x0800	Maintenance mode
0x1000	Replacement value is sent
0x2000	Warning of measured value
0x4000	Fault of measured value
0x8000	Measured valid

Bit encoding of LT3(F) device status

Active (bit encoding)	Explanation
0x0001	Measurement
0x0002	Heating up
0x0003	Calibration
0x0004 ... 0x0100	Not assigned, invalid
0x2000	Maintenance
0x4000	Warning
0x8000	Fault

8 Options

8.5.5 External Connection

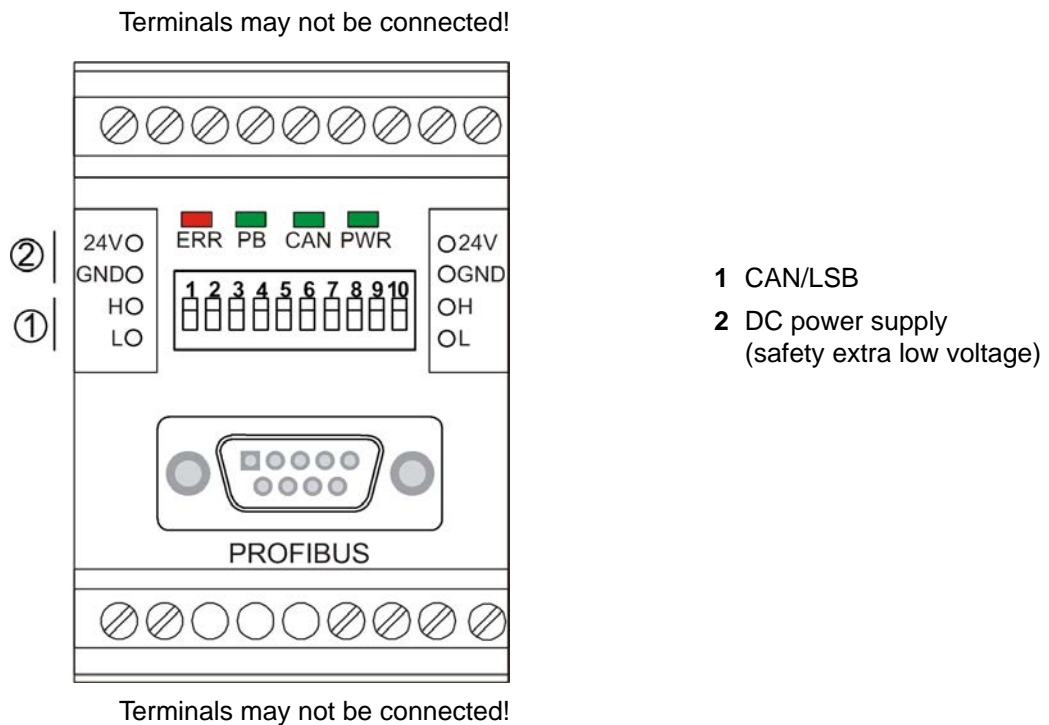

NOTICE

It is prohibited to use the terminals!

Recommendation for line lengths and line cross-sections of the LAMTEC SYSTEM BUS:

- 0 - 40 m 2 x 2 x 0.34 mm², cabled in pairs with screening, impedance 120 Ω
- 40 - 300 m 2 x 2 x 0.5 mm², cabled in pairs with screening, impedance 120 Ω
- 300 - 500 m 2 x 2 x 0.75 mm², cabled in pairs with screening, impedance 120 Ω

Example cable type for fixed installation:

- LAPP cable 2170267 (LAMTEC article no.: 05L05 2 x 2 x 0.5).
- HELU cable 800685.

8.6 LSB Module for Calculating Combustion Efficiency

Setting of LSB address not necessary.

8.6.1 Functional Description

Properties:

- Two Pt100 temperature inputs to record the flue gas temperature and inlet temperature
- Two analogue outputs 0/4 ... 20 mA to emit the flue gas temperature and efficiency
- Power supply 24 VDC/50 mA (PELV)

NOTICE

All outgoing lines from the LSB module must be screened. The screens must be applied to the PE rail as short as possible.

Description of function

The calculation takes place according to the following formula:

$$\eta_F = 100 (q_{Af} + q_{Ag}) \%$$

q_{Af} = flue gas loss due to free heat

q_{Ag} = flue gas loss due to bound heat

$$q_{Af} = (t_A - t_L) * [A_2 / 21 - O_2 + B]$$

The calculation of the flue gas losses is based on the following mean fuel values:

Oil	$A_2 = 0.68;$	$B = 0.007$
Gas	$A_2 = 0.66;$	$B = 0.009$

It is assumed that the combustion takes place free of CO and soot. The flue gas losses due to bound heat q_{Ag} are not taken into consideration.

Function not effective until < 14.9 vol. % O_2 .

Display:

OK oo--	🔒	001
O2:	2.8	%
COe:	280	ppm
ETA:	82.0	%
T-ex:	180.0	°C
T air:	10.0	°C
COe / VV 不 :	42.1	%

ETA efficiency 0 ... 100%

T-ex flue gas temperature 0 ... 400 °C

T air inlet air temperature 0 ... 400 °C

NOTICE

In case of overflow/underflow of the measuring range, the corresponding measured values flash.

NOTICE

The termination resistor (120 Ω) **must** be installed and activated on the first and the last BUS device.

Avoid transmission line!

The terminal resistance can be set via DIP switch 1.

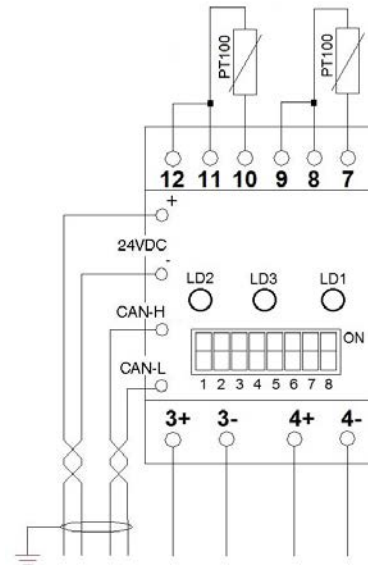

Terminal assignment:

- 10 / 11 / 12** Pt100 temperature input for recording the flue gas temperature 0 ... 400 °C
- 7 / 8 / 9** Pt100 temperature input for recording the inlet temperature 0 ... 400 °C
- 3+ / 3-** Analogue output 3 efficiency
Factory setting: 80 ... 100% → 4 ... 20 mA
- 4+ / 4-** Analogue output 4 (flue gas temperature)
Factory setting: 0 ... 400°C → 4 ... 20 mA

DIP switch settings

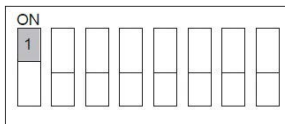

DIP switch 1
LSB terminal resistance 120 Ω

ON active (terminal device)

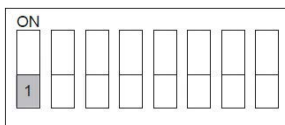

DIP switch 1
LSB terminal resistance 120 Ω

OFF not active

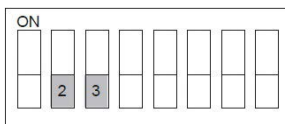

DIP switches 2 and 3
LSB device family 2 (Standard)

2 OFF → 3 OFF

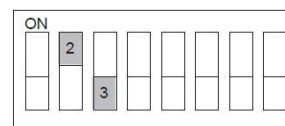

DIP switches 2 and 3
LSB device family 2

2 ON → 3 OFF

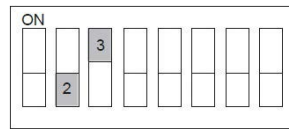

DIP switches 2 and 3
LSB device family 3

2 OFF → 3 ON

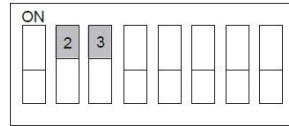

DIP switches 2 and 3
LSB device family 4

2 ON → 3 ON

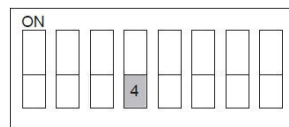

DIP switch 4
Operating mode

OFF → normal mode ON
→ Do not use the programming mode

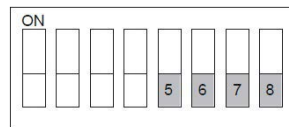

DIP switch 5 - 8
Not assigned

LED status

LED 1 red → ERROR

OFF Normal mode

ON Initialisation not yet performed or not successfully ended (e.g., because the module could not be initialised).

No message has been received for at least 3 seconds.

LED 2 green → POWER

ON Module completely initialised and without error.

LED 3 green → CAN

OFF CAN controller in bus OFF. No communication possible.

FLASHING The CAN controller has discovered temporary faults. After the problem is remedied, the LED continues too flash for a while.

ON CAN is ready for operation.

9 Storage

9.1 Storage Conditions

NOTICE

- ▶ Do not store the device outside without any protection!
 - ▶ When uninstalling, protect the ends of cables and the connectors from corrosion and soiling. Corroded connectors can cause malfunctions.
 - ▶ Always store in a dry location and, if possible, keep in the original packaging.
 - ▶ If possible, always transport in the original packaging.
 - ▶ Transport and storage: - 20°C up to + 70°C.
-

10 Disposal Notes

10.1 Environmental Protection, Waste Disposal

The design of Lambda Transmitter and KS1D is also based on environmental considerations. The modules can easily be separated and sorted into distinct types, and recycled accordingly. The device contains electrical and electronic components and must not be disposed of as domestic waste. The local and currently valid legislation absolutely must be observed.

11 Appendix

11.1 Wet/Dry Measurement Deviations, Conversion Table

NOTICE

The LT3 carries out measurements directly in the humid flue gases (wet measurement). When extractive devices are used, flue gases are removed and prepared. Dry measurements are normally used here, since the humidity has been extracted from the flue gas. As a result, O₂ measurement values vary (see diagrams below).

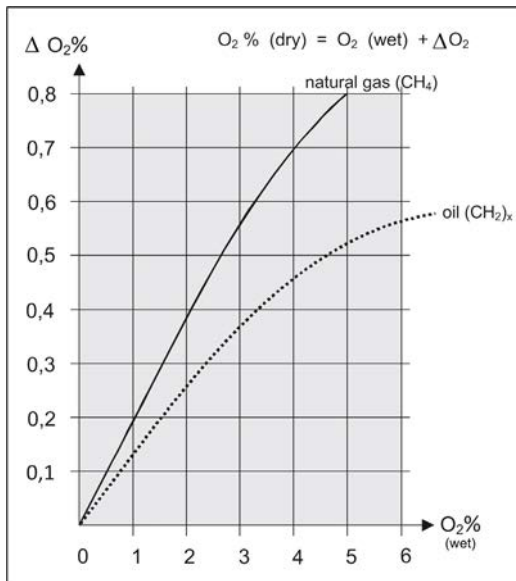

Fig. 11-1 Theoretical max. deviations of the O₂ concentration in wet and dry measurement.
Fuel: natural gas or oil

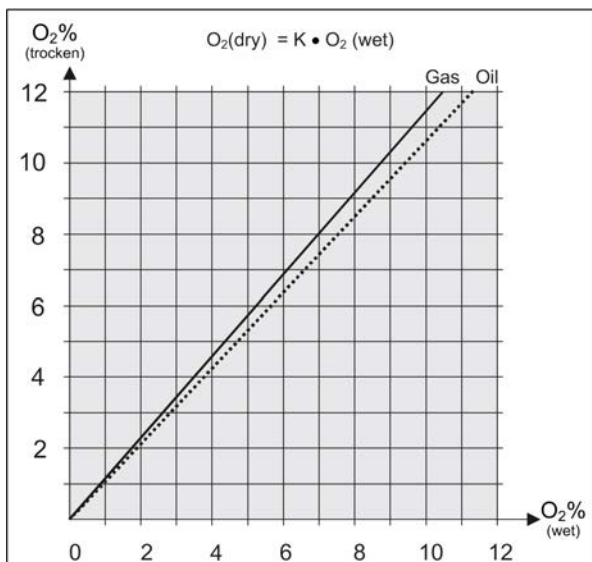
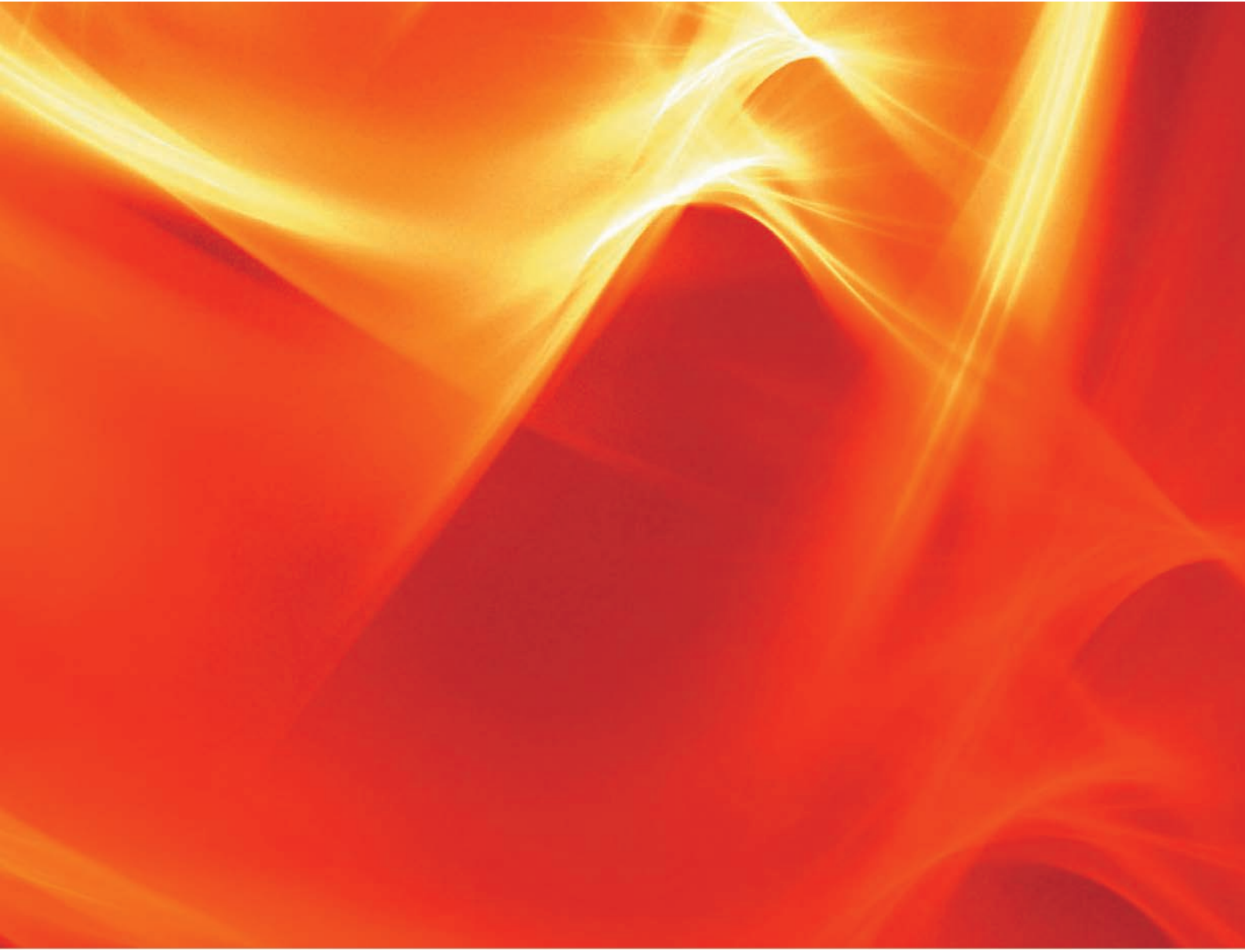

Fig. 11-2 Calibration plot for the concentration values of O₂ (dry) and O₂ (wet)

O ₂ concentration range	Constant C gas/CH ₄	Constant C oil/(CH ₂) _x
0-6 % O ₂	1,18	1,115
6-12 % O ₂	1,08	1,08
0-12 % O ₂	1,15	1,10



The information in this publication is subject to technical changes.



**LAMTEC Meß- und Regeltechnik
für Feuerungen GmbH & Co. KG**

Wiesenstraße 6
D-69190 Walldorf
Telefon: +49 (0) 6227 6052-0
Telefax: +49 (0) 6227 6052-57

info@lamtec.de
www.lamtec.de

