



System Overview

LAMTEC Ignition and Pilot Burner GFI.

Sensors and systems for combustion engineering



www.lamtec.de

SIL 3 Flame Monitoring Device F130I.



CE 0085

2016/426 Gas Appliance Regulations (GAR)

Pressure Equipment Directive 2014/68/EU, CE0036

SIL 3 Confirmation, DIN EN 61508 Parts 1-7

Safety Protection Ex ec IIB+ H2 T4 Gc
Certificate No. IECEX KIWA 20.0005X



PESO

LAMTEC GFI Pilot Burner Series - A New Generation

Pilot burners are required for use on industrial furnaces and firing systems, for the safe ignition of main burners required. The standard version of the GFI series is equipped with an integrated ignition transformer, ionization electrode and SIL3 certified, EC Type approved ionization flame detector.

Advantages:

- Fuel: natural gas, LPG (liquid propane gas), coke gas, refinery gas
- Thermal power up to 3 MW in special design up to 6 MW
- Flame length up to 3 m
- Intermittent- or continuous operation
- SIL 3 certified
- Protection class IP 65
- Available for hazardous areas

Example GFI 35 / GFI 48:



Example GFI 70 / GFI 89:

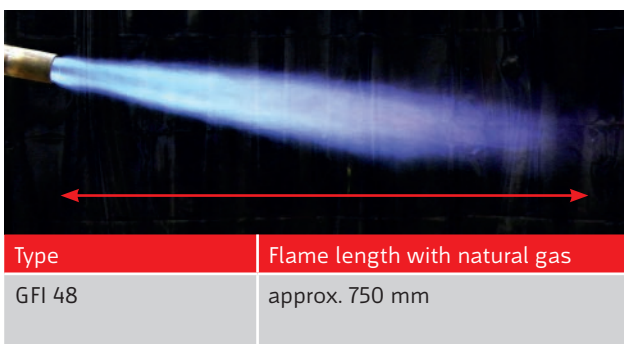
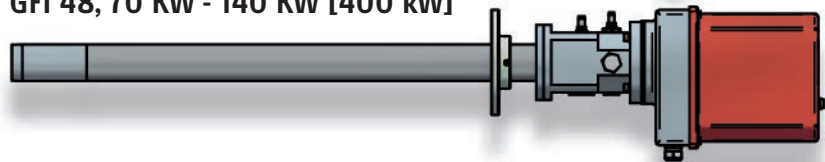

Illustration of GFI Versions

GFI 35, 25 KW - 57 KW



GFI 48, 70 KW - 140 KW [400 kW]



GFI 70, 150 KW - 300 KW [1.000 kW]

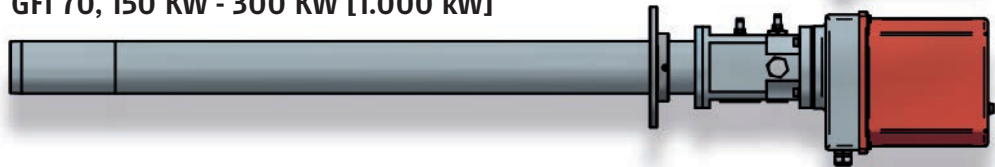

GFI 89, 400 KW - 700 KW [6.000 kW*]



* = Up to 3 MW Propan or NG firing
6 MW only NG firing

GFI product line



GFI with display



GFI without display

Operating principle of GFI Igniters

Forced air operated and muzzle mixing

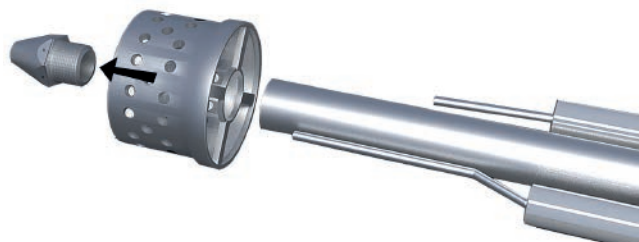

GFI 35.



GFI 35 Adjustment of the flame quality and flame stability

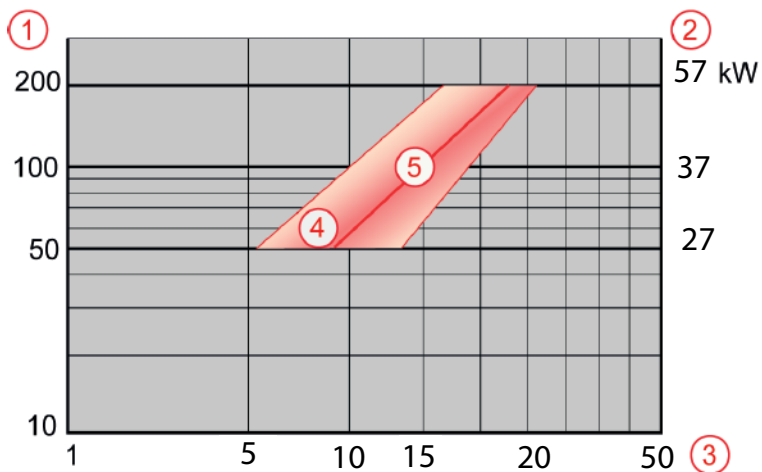

- 1 Gas pre-pressure [mbar]
- 2 Thermal output [kW]
- 3 Airflow [m³/h]
- 4 Stable field of combustion
- 5 Ideal fuel/air ratio setting

	Standard
Tube diameter	35 mm x 2 mm
Mounting flange	Side flange (e.g. DN 50, PN 6)
Thermal power*	27 kW - 57 kW
Flame length	Bis zu 320 - 600 mm
Gas connection	G $\frac{3}{8}$ "
Fuel gas volume flow	2.6 - 5.8 Nm³/h
Air connection	G $\frac{3}{4}$ "
Air volume flow	7.2 - 12.6 Nm³/h (@ 15 mbar) for a maximum heat capacity; if reduced heat capacity, lower air volume flow is needed; additional required air for over stoichiometric combustion shall be available on side.

* At International Standard Atmosphere, ISA: 15 °C, 1013.25 hPa

Components GFI 48.

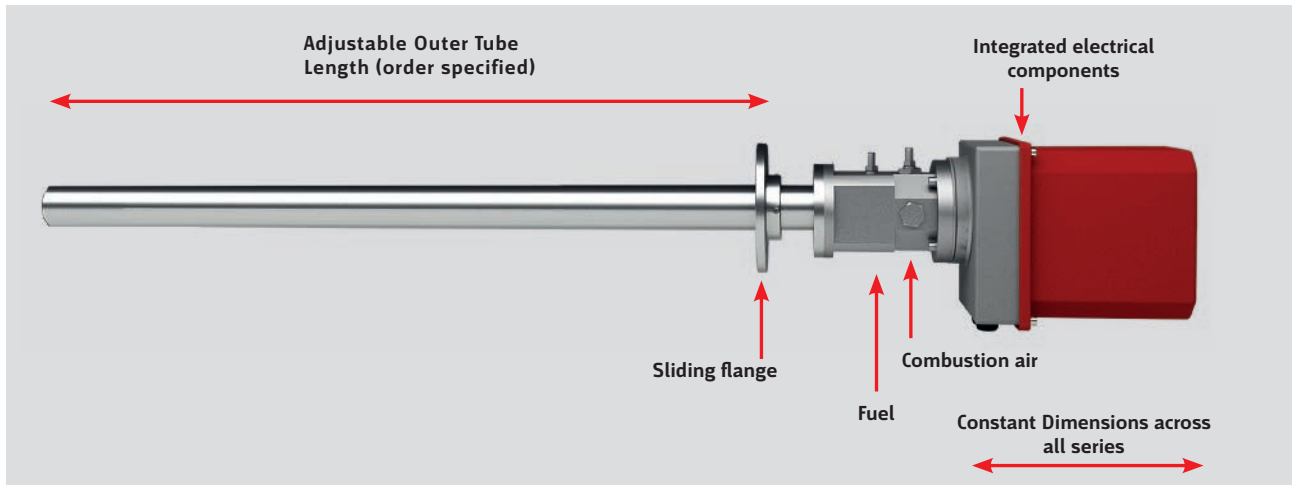

GFI 48 Adjustment of the flame quality and flame stability

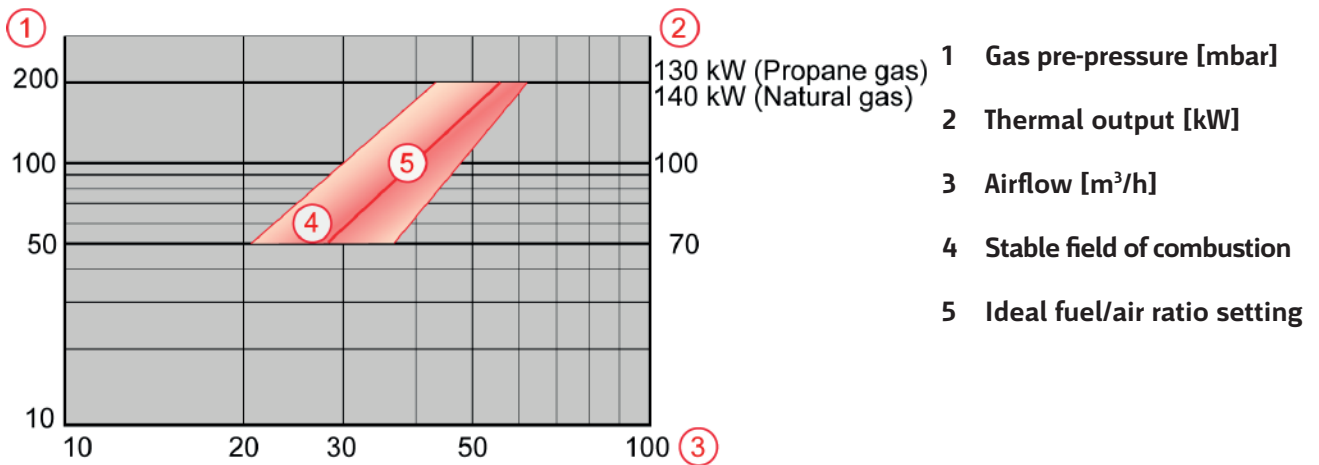

	Standard
Tube diameter	48.3 mm x 2 mm
Mounting flange	Slide flange (e.g. DN 50, PN 6)
Thermal power*	70 kW - 130 kW (Propane gas) 70 kW - 140 kW (Natural gas)
Flame length	Up to 800 mm
Gas connection	1/2" BSPP internal thread
Fuel gas volume flow	15 Nm ³ /h Natural gas (@ 200 mbar) 6 Nm ³ /h Propane (@ 200 mbar)
Air connection	1" BSPP internal thread
Air volume flow	60 Nm ³ /h (@15 mbar) for a maximum heat capacity; if reduced heat capacity, lower air volume flow is needed; additional required air for over stoichiometric combustion shall be available on side.

* At International Standard Atmosphere, ISA: 15 °C, 1013.25 hPa

GFI 70.

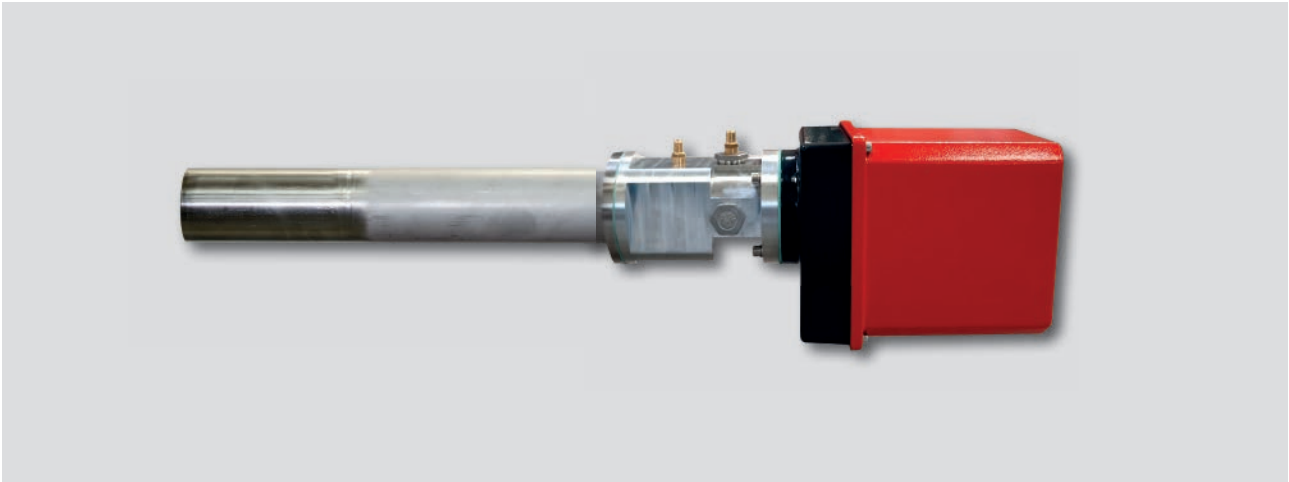

GFI 70 Adjustment of the flame quality and flame stability

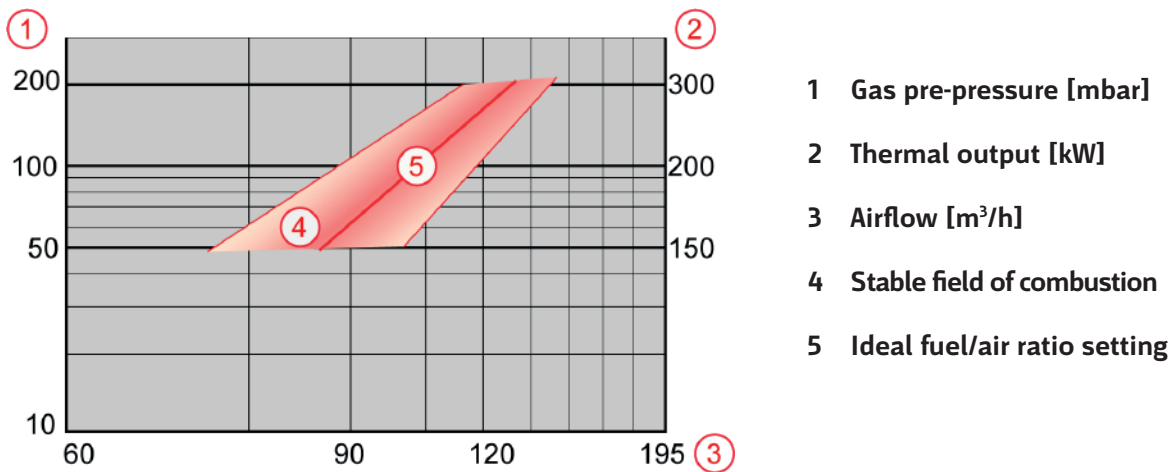

	Standard
Tube diameter	70 mm x 2 mm
Mounting flange	Side flange (e.g. DN 65, PN 6)
Thermal power*	150 kW - 300 kW
Flame length	Up to 1,200 mm
Gas connection	3/4" BSPP internal thread
Fuel gas volume flow	30 Nm³/h Natural gas (@ 200 mbar) 12 Nm³/h Propane (@ 200 mbar)
Air connection	1 1/2" BSPP internal thread
Air volume flow	125 Nm³/h (@ 12 mbar) for a maximum heat capacity; if reduced heat capacity, lower air volume flow is needed; additional required air for over stoichiometric combustion shall be available on side.

* At International Standard Atmosphere, ISA: 15 °C, 1013.25 hPa

GFI 89.



GFI 89 Adjustment of the flame quality and flame stability

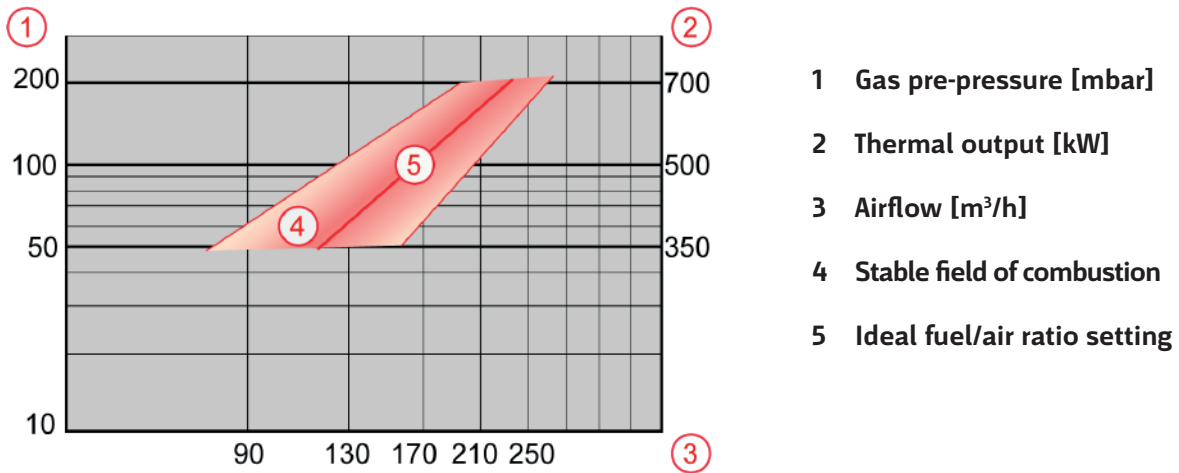

	Standard
Tube diameter	88.9 mm x 2 mm
Mounting flange	Slide flange (e.g. DN 80, PN 6)
Thermal power	400 kW - 700 kW
Flame length	Up to 3,000 mm
Gas connection	1 1/2" BSPP internal thread
Fuel gas volume flow	70 Nm³/h Natural gas (@ 200 mbar) 28 Nm³/h Propane (@ 200 mbar)
Air connection	2" BSPP internal thread
Air volume flow	250 Nm³/h (@ 15 mbar) for a maximum heat capacity; if reduced heat capacity, lower air volume flow is needed; additional required air for over stoichiometric combustion shall be available on side.

* At International Standard Atmosphere, ISA: 15 °C, 1013.25 hPa

Safe Zone Power Unit for GFI



	Standard
Material	Varnished steel RAL7035
Degree of protection	IP 66
Temperature operating range	-20 °C bis +60 °C / -4 ... +140 °F

Ex- Zone I power unit for GFI



	Standard
Explosion protection	II 2 G Ex db IIB + H2 T6/T5 GbII 2 D Ex tb IIIC T80 °C...T95 °C Db
Material	Copper-free aluminium, stainless steel 1.4404/316
Certificates/Test certificates	ITS 15 ATEX 18302X, IECEx ITS 15.0041X, Fa. Rose Systemtechnik
Electrical safety	IP 66 according to EN 60529
Impact resistance	7 Joule according to EN 60079-0
Temperature range	-20 ... +60 °C / -4 ... +140 °F

GFI with integrated power unit EX zone II.

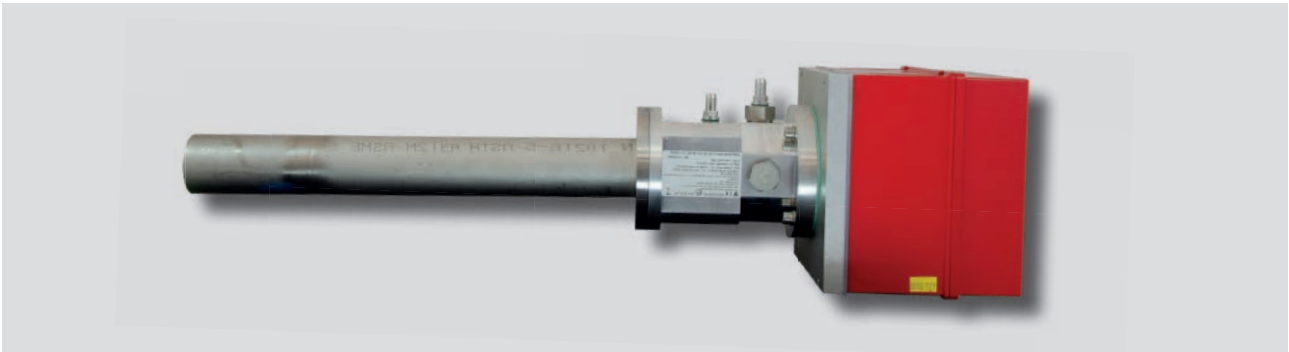

	Standard
Degree of protection	IP 65 / NEMA 4 / NEMA 4X
Type	No display possible
Device marking	Ex ec nC IIB+H2 T4 Gc (with flame scanner) Ex ec IIB+H2 T4 Gc (without flame scanner) certificate no.: IECEx KIWA 20.0005X

EX zone I as well as variant GFI for external power unit



Type	For Ex zone I & variant with external power unit
With standard screw connection	-20 °C ... + 80 °C
With Ex-I conduit screw	-40 °C ... + 80 °C

Technical data.

	Standard
Technical data and features	Gas fired ignitor/pilot burner with integrated high tension transformer, ionisation rod, SIL 3 certified, EU type approved, ionisation flame monitor (IFM)
IFM approved for	Continuous operation
Flame response time	≤ 1 s or ≤ 3 s
SIL classification	SIL 3, flame monitor F130I
Flame signal output	Switching contact additional 0-300 mV on measuring sockets for commissioning support intensity display (optional)
Ambient temperature Safe Area (permissible temperature range)	-20... + 60 °C (standard, without display) -40... + 60 °C (special, without display) 0... + 60 °C (with display)
Ambient temperature Ex zone II (permissible temperature range)	-20... + 60 °C
Amplifier	1 potential free NO contact, 230 VAC, 0.5 A
Supply voltage	120 - 127 VAC, 220 - 230 VAC (-15 % / +10 %), 50/60 Hz
Ignition voltage	8 kV (at U _N = 230 V), 7 kV (at U _N = 120 V)
Power input	U _N = 230 V, 230 VA spark igniter ≤ 10 VA flame monitor U _N = 120 V, 192 VA spark igniter ≤ 10 VA flame monitor
Electrical connection	Plug connection with pre-assembled cable
Cable length	2 - 100 m
IP protection	IP65
Housing material (electric)	Aluminium, seawater resistant aluminium (optional)
Tube length	300 - 6,000 mm
Tube material	Stainless steel 1,4301 or 1,4571 optional Heat resistant end tube 1,4841
Fuel gas	Natural gas, butane/propane Coke oven gas and special gases (optional)
Fuel gas supply pressure	50 - 200 mbar (effective)
Air supply pressure	Depending on size
Cooling air flow	Depending on size, at least 50 % combustion air flow

Valid for all versions



**LAMTEC Meß- und Regeltechnik
für Feuerungen GmbH & Co. KG**

Josef-Reiert-Straße 26
D-69190 Walldorf
Telefon: +49 (0) 6227 6052-0
Telefax: +49 (0) 6227 6052-57

info@lamtec.de

www.lamtec.de

